



 **RED HEAD®**

A7+

SUBMITTAL PACKAGE

**MAXIMUM VERSATILITY
INCREASES ANCHOR RELIABILITY
AND JOBSITE PRODUCTIVITY**

**QUICK-CURE ADHESIVE ANCHOR FOR
CONCRETE AND MASONRY APPLICATIONS**

A7+

The Most Versatile Quick Cure Adhesive



A7P-10

A7P-28

APPLICATIONS / USES

- Concrete dowelling (slabs, walls, columns)
- Steel framing (columns, beams, ledgers)
- Brick pinning and CMU reinforcement
- Architectural metal fastening (railings, signage)
- Mechanical, electrical, and plumbing attachment
- Vibratory equipment anchoring

DESCRIPTION

Quick Curing Hybrid Epoxy Adhesive

RED HEAD A7+ is a high-strength, fast-cure adhesive that is designed to securely anchor threaded rod and rebar to cured concrete and masonry. A7+ is one of the most versatile anchoring solutions on the market, suitable for use in an extremely wide range of applications and environmental conditions.

- Qualified for use in concrete, brick, block, and clay tile
- ICC-ES approved for cracked concrete and seismic applications (ICC-ES ESR 3903).
- Cures in only 45 minutes (at base temperature of 70°F/21°C)
- No extra time required for drying saturated concrete or water-filled holes
- Easy pumping even in cold temperatures
- Low odor - suitable for use indoors and in occupied buildings
- Optimum viscosity simplifies use in overhead and horizontal holes
- 18-month storage life minimizes waste and risk of using expired product
- Rugged cartridge resists breakage due to rough handling or cold temperatures

ADVANTAGES

- All weather formula
- Works in damp holes and underwater applications
- Fast curing time, 45 minutes at 70°F
- ICC-ES Evaluation Report ESR-3903 (Concrete) and ESR-3951 (Masonry)
- NSF 61 Listed
- S75 high flow nozzle reduces installation time
- Fast & easy dispensing, even 28 ounce cartridge can be hand dispensed

Curing Times

CONCRETE (F°)	ADHESIVE (F°)	GEL TIME	FULL CURE TIME
110	110	1.5 minutes	45 minutes
90	90	3 minutes	45 minutes
70	70	5 minutes	45 minutes
50	50	15 minutes	90 minutes
30	30	35 minutes	4 hours
14	30	35 minutes	24 hours

Most Competitive Spacing and Edge Distance

NOMINAL ANCHOR DIAMETER (IN.)	MINIMUM SPACING (IN.)	MINIMUM EDGE DISTANCE (IN.)
3/8	15/16	15/16
1/2	1-1/2	1-1/2
5/8	2-1/2	2-1/2
3/4	3	3
7/8	3-1/2	3-1/2
1	4	4
1-1/4	5	5

INSTALLATION STEPS

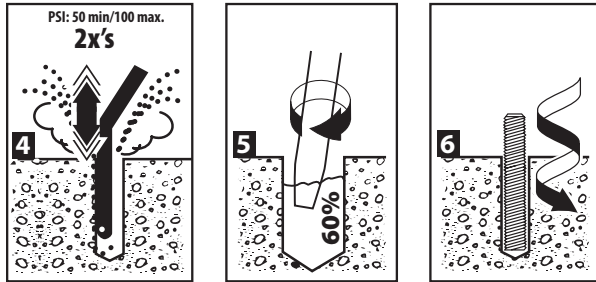
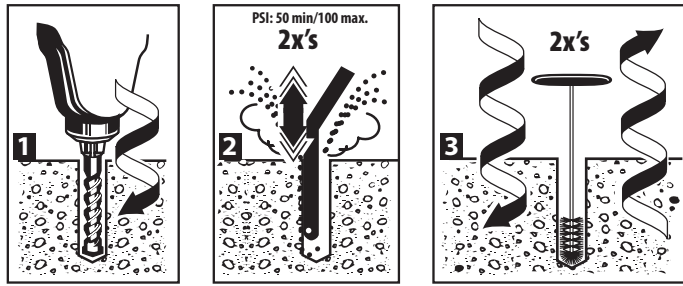

* Damp, submerged and underwater applications require 4x's air, 4x's brushing and 4x's air

APPROVALS/LISTINGS

ICC-ES ESR-3903 for Cracked and Uncracked concrete including all Seismic Zones

ICC-ES ESR-3951 for masonry

IBC 2006/2009/2012/2015 Compliant

NSF/ANSI Standard 61

For the most current approvals/listings visit: www.itwredhead.com

APPLICATIONS

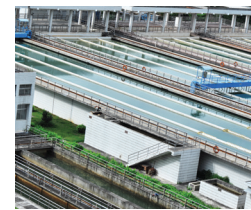

Water Treatment Facilities

The best-in-class in edge and spacing distance of Red Head A7+ and its ability to work in water have made it a great fit for waste water treatment plants.







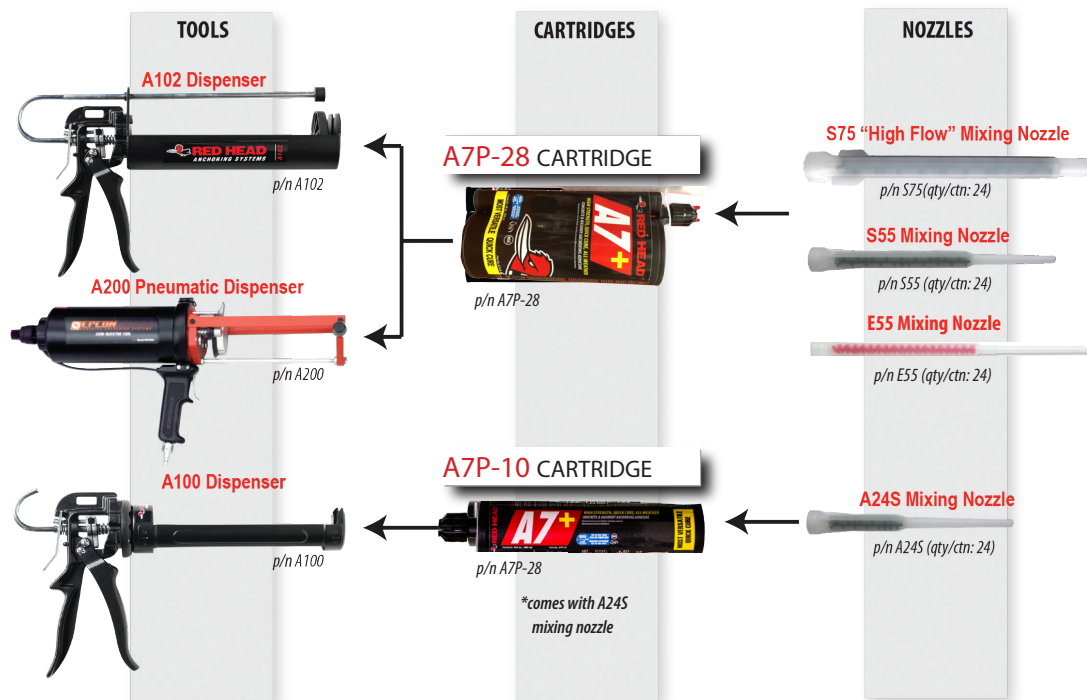

Roadway Doweling

A7+ dispenses so quickly and rebar inserts so easily that contractors find installed costs are lower than many other products including grout for doweling.



A7P-28 fl. oz. Ordering Information

PART NUMBER	DESCRIPTION	BOX QTY	PART NUMBER	DESCRIPTION	BOX QTY
 A7P-28	28 Fluid Ounce Cartridge A7+ Each cartridge comes with a S55 Nozzle	4	 E25-6	6-Foot Straight Tubing (Used when holes are deeper) (can cut to proper size) (.39 in I.D. x .43 in. O.D.)	6
 E55	Mixing Nozzle for A7P-28 and G5-22 Cartridge Nozzle diameter fits 3/8" to 5/8" holes. (overall length of nozzle 14")	24	 A200	Pneumatic Dispenser for A7P-28 Cartridge	1
 A102	Largest hand dispensable cartridge— still easy to dispense Hand Dispenser for A7P-28 Cartridge	1	 S55	Mixing Nozzle for A7P-28 Cartridge Nozzle diameter fits holes for 3/8" diameter & larger anchors (overall length of nozzle 10")	24

ESTIMATING TABLE

A7+ Number of Anchoring Installations per Cartridge* 28 Fluid Ounce Cartridge Using Reinforcing Bar with A7+ Adhesive in Solid Concrete

REBAR	DRILL HOLE DIA. INCHES	EMBEDMENT DEPTH IN INCHES (mm)														
		1 (25.4)	2 (50.8)	3 (76.2)	4 (101.6)	5 (127.0)	6 (152.4)	7 (177.8)	8 (203.2)	9 (228.6)	10 (254.0)	11 (279.4)	12 (304.8)	13 (330.2)	14 (355.6)	15 (381.0)
# 3	7/16	662.5	331.3	220.8	165.6	132.5	110.4	94.6	82.8	73.6	66.3	60.2	55.2	51.0	47.3	44.2
# 4	5/8	373.0	186.5	124.3	93.2	74.6	62.2	53.3	46.6	41.4	37.3	33.9	31.1	28.7	26.6	24.9
# 5	3/4	286.1	143.0	95.4	71.5	57.2	47.7	40.9	35.8	31.8	28.6	26.0	23.8	22.0	20.4	19.1
# 6	7/8	231.0	115.5	77.0	57.7	46.2	38.5	33.3	28.8	25.7	23.1	21.0	19.2	17.8	16.5	15.4
# 7	1	213.4	106.7	71.1	53.3	42.7	35.6	30.5	26.7	23.7	21.3	19.4	17.8	16.4	15.2	14.2
# 8	1-1/8	177.3	88.6	59.1	44.3	35.5	29.5	25.3	22.2	19.7	17.7	16.1	14.8	13.6	12.7	11.8
# 9	1-1/4	102.8	51.4	34.3	25.7	20.6	17.1	14.7	12.8	11.4	10.3	9.3	8.6	7.9	7.3	6.9
# 10	1-1/2	84.1	42.0	28.0	21.0	16.8	14.0	12.0	10.5	9.3	8.4	7.6	7.0	6.5	6.0	5.6
# 11	1-3/4	51.4	25.7	17.1	12.8	10.3	8.6	7.3	6.4	5.7	5.1	4.7	4.3	4.0	3.7	3.4

* The number of anchoring installations is based upon calculations of hole volumes using ANSI tolerance carbide tipped drill bits, the nominal areas of the reinforcing bars and the stress areas of the threaded rods. These estimates do not account for waste.



ESTIMATING TABLE

A7+ Number of Anchoring Installations per Cartridge* 28 Fluid Ounce Cartridge Using Threaded Rod with A7+ Adhesive in Solid Concrete

ROD In. (mm)	DRILL HOLE DIA. INCHES	EMBEDMENT DEPTH IN INCHES (mm)														
		1 (25.4)	2 (50.8)	3 (76.2)	4 (101.6)	5 (127.0)	6 (152.4)	7 (177.8)	8 (203.2)	9 (228.6)	10 (254.0)	11 (279.4)	12 (304.8)	13 (330.2)	14 (355.6)	15 (381.0)
1/4 (6.4)	5/16	915.5	457.7	305.2	228.9	183.1	152.8	130.8	114.4	101.7	91.5	83.2	76.3	70.4	65.4	61.0
3/8 (9.5)	7/16	530.0	265.0	176.7	132.5	106.0	88.3	75.7	66.3	58.9	53.0	48.2	44.2	40.8	37.9	35.3
1/2 (12.7)	9/16	381.4	190.7	127.1	95.4	76.3	63.6	54.5	47.7	42.4	38.1	34.7	31.8	29.3	27.2	25.4
5/8 (15.9)	3/4	195.6	97.8	65.1	48.8	39.0	32.5	27.9	24.4	21.7	19.5	17.7	16.3	15.0	13.9	13.0
3/4 (19.1)	7/8	154.4	77.2	51.5	38.6	30.9	25.7	22.1	19.3	17.2	15.4	14.0	12.9	11.9	11.0	10.3
7/8 (22.2)	1	128.0	64.0	42.8	32.0	25.6	21.4	18.3	16.0	14.2	12.8	11.6	10.7	9.9	9.2	8.5
1 (25.4)	1-1/8	105.2	52.6	35.2	26.3	21.1	17.6	15.0	13.2	11.7	10.5	9.6	8.8	8.1	7.6	7.0
1-1/4 (31.8)	1-3/8	80.0	40.0	26.6	20.0	15.9	13.3	11.4	10.0	8.9	8.0	7.2	6.6	6.1	5.7	5.3

* The number of anchoring installations is based upon calculations of hole volumes using ANSI tolerance carbide tipped drill bits, the nominal areas of the reinforcing bars and the stress areas of the threaded rods. These estimates do not account for waste.

A7P-10 fl. oz. Ordering Information

PART NUMBER	DESCRIPTION	BOX QTY
 A7P-10	9.5 Fluid Ounce Cartridge with Nozzle	6
 A24S	Mixing Nozzle for A7P-10 Cartridge Nozzle diameter fits 3/8" to 5/8" holes (overall length of nozzle 6-3/8")	24
 A100	Hand Dispenser Designed for A7P-10 Cartridge Contractor Quality 26:1 Thrust Ratio	1

PACKAGING

1. Disposable, self-contained cartridge system capable of dispensing both components in the proper mixing ratio
2. Acrylic components dispensed through a static mixing nozzle that thoroughly mixes the material and places the material at the base of the pre-drilled hole
3. Cartridge markings: Include manufacturer's name, batch number and best-used-by date, mix ratio by volume, ANSI hazard classification, and appropriate ANSI handling precautions

SUGGESTED SPECIFICATIONS

ACRYLIC ADHESIVE:

1. Meets NSF Standard 61, certified for use in conjunction with drinking water systems.
2. Works in wet, damp, submerged holes.
3. Shelf life: Best if used within 18 months.
4. All weather, cure time (45 min. at 70°F).
5. Dispenses easier and faster.
6. Dispenses and cures faster in cold weather, alsoworks in hot weather.
7. Pumpable at 32°F without preheating.
8. Formula for use in solid and hollow base materials.
9. Suitable for oversized and diamond cored holes with increased depths.
10. Quick insertion time = less labor cost.

ESTIMATING TABLES

A7+ 9.5 Fluid Ounce Cartridge



Number of Anchoring Installations per Cartridge* Using Reinforcing Bar and Threaded Rod with A7+ Adhesive in Solid Concrete

REBAR	DRILL HOLE DIA. INCHES	EMBEDMENT DEPTH IN INCHES (mm)			
		2 (50.8)	4 (101.6)	6 (152.4)	8 (203.2)
# 3	7/16	110	55	37	27
# 4	5/8	63	31	20	14
# 5	3/4	48	24	16	11
# 6	7/8	39	18	13	9
# 7	1	35	18	11	9
# 8	1-1/8	29	14	9	7

ROD In (mm)	DRILL HOLE DIA. INCHES	EMBEDMENT DEPTH IN INCHES (mm)				
		2 (50.8)	4 (101.6)	6 (152.4)	8 (203.2)	10 (254.0)
3/8 (9.5)	7/16	88	44	28	22	18
1/2 (12.7)	9/16	65	31	22	16	13
5/8 (15.9)	3/4	33	16	11	7	6.5
3/4 (19.1)	7/8	26	13	9	7	5
7/8 (22.2)	1	22	11	7	5	4.5
1 (25.4)	1-1/8	18	9	5	3	3.5

* The number of anchoring installations is based upon calculations of hole volumes using ANSI tolerance carbide tipped drill bits, the nominal areas of the reinforcing bars and the stress areas of the threaded rods. These estimates do not account for waste.

A7P-5 fl. oz. Ordering Information

PART NUMBER	DESCRIPTION	BOX QTY	PART NUMBER	DESCRIPTION	BOX QTY
 A7P-500KIT	Convenient Dispensing Kit Packaged in a Solid Plastic Shell with (1) A500 Plastic Dispenser (1) A7P-5 Cartridge and (1) A24 Nozzle Nozzle diameter fits 3/8" to 5/8" holes	8	 A7P-501KIT	Convenient Dispensing Kit Packaged in a Solid Plastic Shell with (1) A501 Plastic Dispenser (1) A7P-5 Cartridge and (1) A24 Nozzle Nozzle diameter fits 3/8" to 5/8" holes	8

AVAILABLE WITH YOUR CHOICE OF TWO, EASY DISPENSING SYSTEMS

A500 PLASTIC DISPENSER

Attaches directly to cartridge allowing for easy hand dispensing. **No extra tools are required.**



Simple Assembly and Dispensing

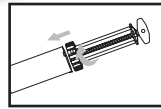

1. Twist-lock dispenser onto cartridge.

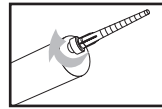

2. Thread nozzle onto cartridge.

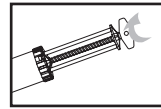

3. Turn lever in order to dispense adhesive.

EASY PACKAGING!

A500 and A501 kits are perfect for both counter or pegboard hanging display.



A7P-500KIT

A501 CAULKING GUN ADAPTOR

Allows cartridge to work with most standard caulking guns (caulking gun supplied by contractor).



Simple Assembly and Dispensing

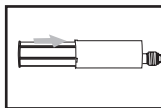

1. Push adaptor tightly against back of cartridge.

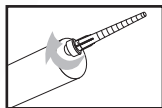

2. Thread nozzle onto cartridge.

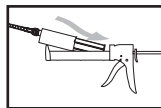

3. Place assembly in caulking gun and dispense adhesive.



A7P-501KIT

ESTIMATING TABLES

A7+ 5 Fluid Ounce Cartridge *Number of Anchoring Installations per Cartridge* Using Reinforcing Bar and Threaded Rod with A7+ Adhesive in Solid Concrete*

REBAR	DRILL HOLE DIA. INCHES	EMBEDMENT DEPTH IN INCHES (mm)			
		2 (50.8)	4 (101.6)	6 (152.4)	8 (203.2)
# 3	7/16	60	30	20	15
# 4	5/8	34	17	11	8
# 5	3/4	26	13	9	6
# 6	7/8	21	10	7	5
# 7	1	19	10	6	5
# 8	1-1/8	16	8	5	4

ROD In (mm)	DRILL HOLE DIA. INCHES	EMBEDMENT DEPTH IN INCHES (mm)			
		2 (50.8)	4 (101.6)	6 (152.4)	8 (203.2)
3/8 (9.5)	7/16	48	24	16	12
1/2 (12.7)	9/16	35	17	12	9
5/8 (15.9)	3/4	18	9	6	4
3/4 (19.1)	7/8	14	7	5	4
7/8 (22.2)	1	12	6	4	3
1 (25.4)	1-1/8	10	5	3	2

* The number of anchoring installations is based upon calculations of hole volumes using ANSI tolerance carbide tipped drill bits, the nominal areas of the reinforcing bars and the stress areas of the threaded rods. These estimates do not account for waste.

PERFORMANCE TABLE

A7+ Quick-Cure Adhesive

Average Ultimate Tension and Shear Loads^{1,2,3} for Threaded Rod Installed in Solid Concrete

THREADED ROD DIA. In. (mm)	DRILL HOLE DIAMETER In. (mm)	MAX. CLAMPING FORCE AFTER PROPER CURE Ft.-Lbs. (Nm)	EMBEDMENT IN CONCRETE In. (mm)	2000 PSI (13.8 MPa) CONCRETE		4000 PSI (27.6 MPa) CONCRETE	
				ULTIMATE TENSION Lbs. (kN)	ULTIMATE SHEAR Lbs. (kN)	ULTIMATE TENSION Lbs. (kN)	ULTIMATE SHEAR Lbs. (kN)
3/8 (9.5)	7/16 (11.1)	13 - 18 (17-24)	1-1/2 (38.1)	N/A	N/A	3,734 (16.6)	4,126 (18.3)
			3-3/8 (85.7)	5,852 (26.0)	5,220 (23.2)	10,977 (48.8)	5,220 (23.2)
			4-1/2 (114.3)	7,729 (34.4)	5,220 (23.2)	11,661 (51.9)	5,220 (23.2)
1/2 (12.7)	9/16 (14.3)	22 - 25 (29-33)	2 (50.8)	N/A	N/A	6,022 (26.8)	8,029 (35.7)
			4-1/2 (114.3)	10,798 (48.0)	8,029 (35.7)	17,162 (76.3)	8,029 (35.7)
			6 (152.4)	14,210 (63.2)	8,029 (35.7)	17,372 (77.3)	8,029 (35.7)
5/8 (15.9)	3/4 (19.1)	55 - 80 (74-108)	2-1/2 (63.5)	N/A	N/A	7,330 (32.6)	11,256 (50.1)
			5-5/8 (142.9)	16,417 (73.0)	15,967 (71.0)	26,504 (117.9)	15,967 (71.0)
			7-1/2 (190.5)	18,747 (83.4)	15,967 (71.0)	29,381 (130.7)	15,967 (71.0)
3/4 (19.1)	7/8 (22.2)	106 - 160 (143-216)	3 (76.2)	N/A	N/A	8,634 (38.4)	20,126 (89.5)
			6-3/4 (171.5)	18,618 (82.8)	20,126 (89.5)	29,727 (132.2)	20,126 (89.5)
			9 (228.6)	23,934 (106.5)	20,126 (89.5)	37,728 (167.8)	20,126 (89.5)
7/8 (22.2)	1 (25.4)	185 - 250 (250-338)	3-1/2 (88.9)	N/A	N/A	13,650 (60.7)	20,920 (92.9)
			7-7/8 (200.0)	N/A	29,866 (132.9)	44,915 (199.8)	29,866 (132.9)
			10-1/2 (266.7)	36,881 (164.1)	29,866 (132.9)	48,321 (215.0)	29,866 (132.9)
1 (25.4)	1-1/8 (28.6)	276 - 330 (374-447)	4 (101.6)	N/A	N/A	16,266 (72.2)	33,152 (147.5)
			9 (228.6)	32,215 (143.3)	37,538 (167.0)	48,209 (214.5)	37,538 (167.0)
			12 (304.8)	46,064 (204.9)	37,538 (167.0)	63,950 (284.5)	37,538 (167.0)
1-1/4 (31.8)	1-3/8 (34.9)	370 - 660 (501-894)	5 (127.0)	N/A	N/A	21,838 (97.1)	33,152 (147.5)
			11-1/4 (285.8)	45,962 (204.5)	58,412 (259.8)	56,715 (252.3)	58,412 (259.8)
			15 (381.0)	62,208 (276.7)	58,412 (259.8)	84,385 (375.4)	58,412 (259.8)

1 Allowable working loads for the single installations under static loading should not exceed 25% capacity or the allowable load of the anchor rod. Divide by 4.

2 Ultimate load values in 2000 and 4000 psi stone aggregate concrete. Ultimate loads are indicated for the embedment shown in the Embedment in Concrete column. Performance values are based on the use of high strength threaded rod (ASTM A193 Gr. B7). The use of lower strength rods will result in lower ultimate tension and shear loads.

3 Linear interpolation may be used for intermediate spacing and edge distances.

PERFORMANCE TABLE

A7+ Quick-Cure Adhesive

Allowable Tension Loads¹ for Threaded Rod Installed in Solid Concrete

THREADED ROD DIA. In. (mm)	DRILL HOLE DIAMETER In. (mm)	MIN. EMBEDMENT DEPTH In. (mm)	ALLOWABLE TENSION LOAD BASED ON ADHESIVE BOND STRENGTH		ALLOWABLE TENSION LOAD BASED ON STEEL STRENGTH		
			2000 PSI (13.8 MPa) CONCRETE Lbs. (kN)	4000 PSI (27.6 MPa) CONCRETE Lbs. (kN)	ASTM A307 (SAE 1018) Lbs. (kN)	ASTM A193 GR. B7 (SAE 4140) Lbs. (kN)	ASTM F593 AISI 304 SS Lbs. (kN)
3/8 (9.5)	7/16 (11.1)	1-1/2 (38.1)	N/A	934 (4.2)	2,080 (9.3)	4,340 (19.3)	3,995 (17.8)
		3-3/8 (85.7)	1,460 (6.5)	2,740 (12.2)	2,080 (9.3)	4,340 (19.3)	3,995 (17.8)
		4-1/2 (114.3)	1,930 (8.6)	2,915 (13.0)	2,080 (9.3)	4,340 (19.3)	3,995 (17.8)
1/2 (12.7)	9/16 (14.3)	2 (50.8)	N/A	1,505 (6.7)	3,730 (16.6)	7,780 (34.6)	7,155 (31.8)
		4-1/2 (114.3)	2,700 (12.0)	4,290 (19.1)	3,730 (16.6)	7,780 (34.6)	7,155 (31.8)
		6 (152.4)	3,550 (15.8)	4,340 (19.3)	3,730 (16.6)	7,780 (34.6)	7,155 (31.8)
5/8 (15.9)	3/4 (19.1)	2-1/2 (63.5)	N/A	1,832 (8.2)	5,870 (26.1)	12,230 (54.4)	11,250 (50.0)
		5-5/8 (142.9)	4,100 (18.3)	6,625 (29.5)	5,870 (26.1)	12,230 (54.4)	11,250 (50.0)
		7-1/2 (190.5)	4,685 (20.8)	7,345 (32.7)	5,870 (26.1)	12,230 (54.4)	11,250 (50.0)
3/4 (19.1)	7/8 (22.2)	3 (76.2)	N/A	2,158 (9.6)	8,490 (37.8)	17,690 (78.7)	14,860 (66.1)
		6-3/4 (171.5)	4,655 (20.7)	7,430 (33.1)	8,490 (37.8)	17,690 (78.7)	14,860 (66.1)
		9 (228.6)	5,980 (26.6)	9,430 (42.0)	8,490 (37.8)	17,690 (78.7)	14,860 (66.1)
7/8 (22.2)	1 (25.4)	3-1/2 (88.9)	N/A	3,413 (15.2)	11,600 (51.6)	25,510 (113.5)	20,835 (92.7)
		7-7/8 (200.0)	N/A	11,230 (49.9)	11,600 (51.6)	25,510 (113.5)	20,835 (92.7)
		10-1/2 (266.7)	9,220 (41.0)	12,080 (53.7)	11,600 (51.6)	25,510 (113.5)	20,834 (92.7)
1 (25.4)	1-1/8 (28.6)	4 (101.6)	N/A	4,067 (18.1)	15,180 (67.5)	31,620 (140.7)	26,560 (118.1)
		9 (228.6)	8,050 (35.8)	12,050 (53.6)	15,180 (67.5)	31,620 (140.7)	26,560 (118.1)
		12 (304.8)	11,515 (51.2)	15,985 (71.1)	15,180 (67.5)	31,620 (140.7)	26,560 (118.1)
1-1/4 (31.8)	1-3/8 (34.9)	5 (127.0)	N/A	5,460 (24.3)	23,800 (105.9)	49,580 (220.6)	34,670 (154.2)
		11-1/4 (285.8)	11,490 (51.1)	14,175 (63.1)	23,800 (105.9)	49,580 (220.6)	34,670 (154.2)
		15 (381.0)	15,550 (69.2)	21,095 (93.8)	23,800 (105.9)	49,580 (220.6)	34,670 (154.2)

1 Use lower value of either bond or steel strength for allowable tensile load.

PERFORMANCE TABLE

A7+ Quick-Cure Adhesive **Allowable Shear Loads¹ for Threaded Rod Installed in Solid Concrete**

THREADED ROD DIA. In. (mm)	DRILL HOLE DIAMETER In. (mm)	MIN. EMBEDMENT DEPTH In. (mm)	ALLOWABLE SHEAR LOAD BASED ON CONCRETE STRENGTH		ALLOWABLE SHEAR LOAD BASED ON STEEL STRENGTH		
			2000 PSI (13.8 MPa) CONCRETE Lbs. (kN)	4000 PSI (27.6 MPa) CONCRETE Lbs. (kN)	ASTM A307 (SAE 1018) Lbs. (kN)	ASTM A193 GR. B7 (SAE 4140) Lbs. (kN)	ASTM F593 AISI 304 SS Lbs. (kN)
3/8 (9.5)	7/16 (11.1)	1-1/2 (38.1)	N/A	1,031 (4.6)	1,040 (4.6)	2,170 (9.7)	1,995 (8.9)
		3-3/8 (85.7)	1,305 (5.8)	1,305 (5.8)	1,040 (4.6)	2,170 (9.7)	1,995 (8.9)
1/2 (12.7)	9/16 (14.3)	2 (50.8)	N/A	2,005 (8.9)	1,870 (8.3)	3,895 (17.3)	3,585 (15.9)
		4-1/2 (114.3)	2,005 (8.9)	2,005 (8.9)	1,870 (8.3)	3,895 (17.3)	3,585 (15.9)
5/8 (15.9)	3/4 (19.1)	2-1/2 (63.5)	N/A	2,814 (12.5)	2,940 (13.1)	6,125 (27.2)	5,635 (25.1)
		5-5/8 (142.9)	3,990 (17.8)	3,990 (17.8)	2,940 (13.1)	6,125 (27.2)	5,635 (25.1)
3/4 (19.1)	7/8 (22.2)	3 (76.2)	N/A	5,030 (22.4)	4,250 (18.9)	8,855 (39.4)	7,440 (33.1)
		6-3/4 (171.5)	5,030 (22.4)	5,030 (22.4)	4,250 (18.9)	8,855 (39.4)	7,440 (33.1)
7/8 (22.2)	1 (25.4)	3-1/2 (88.9)	N/A	5,230 (23.3)	5,800 (25.8)	12,760 (56.8)	10,730 (47.7)
		7-7/8 (200.0)	7,465 (33.2)	7,465 (33.2)	5,800 (25.8)	12,760 (56.8)	10,730 (47.7)
1 (25.4)	1-1/8 (28.6)	4 (101.6)	N/A	8,288 (36.9)	7,590 (33.8)	15,810 (70.3)	13,285 (59.1)
		9 (228.6)	9,385 (41.7)	9,385 (41.7)	7,590 (33.8)	15,810 (70.3)	13,285 (59.1)
1-1/4 (31.8)	1-3/8 (34.9)	5 (127.0)	N/A	8,288 (36.9)	11,900 (52.9)	24,790 (100.3)	18,840 (83.8)
		11-1/4 (285.8)	14,600 (64.9)	14,600 (64.9)	11,900 (52.9)	24,790 (100.3)	18,840 (83.8)

1 Use lower value of either concrete or steel strength for allowable shear load.

PERFORMANCE TABLE

A7+ Quick-Cure Adhesive **Average Ultimate Tension Loads^{1,2,3} for Reinforcing Bar Installed in Solid Concrete**

REINFORCING BAR DIA. In. (mm)	EMBEDMENT IN CONCRETE In. (mm)	2000 PSI (13.8 MPa) CONCRETE ULTIMATE TENSION Lbs. (kN)	4000 PSI (27.6 MPa) CONCRETE ULTIMATE TENSION Lbs. (kN)	ULTIMATE TENSILE AND YIELD STRENGTH GRADE 60 REBAR	
				MINIMUM YIELD STRENGTH Lbs. (kN)	MINIMUM ULTIMATE TENSILE STRENGTH Lbs. (kN)
# 3 (9.5)	3-3/8 (85.7)	6,180 (27.5)	8,324 (37.0)	6,600 (29.4)	9,900 (44.0)
	4-1/2 (114.3)	7,560 (33.6)	11,418 (50.8)	6,600 (29.4)	9,900 (44.0)
# 4 (12.7)	4-1/2 (114.3)	9,949 (44.3)	16,657 (74.1)	12,000 (53.4)	18,000 (80.1)
	6 (152.4)	15,038 (66.9)	17,828 (79.3)	12,000 (53.4)	18,000 (80.1)
# 5 (15.9)	5-5/8 (142.9)	14,012 (62.3)	20,896 (93.0)	18,600 (82.7)	27,900 (124.1)
	7-1/2 (190.5)	16,718 (74.4)	26,072 (116.0)	18,600 (82.7)	27,900 (124.1)
# 6 (19.1)	6-3/4 (171.5)	21,247 (94.5)	26,691 (118.7)	26,400 (117.4)	39,600 (176.2)
	9 (228.6)	33,325 (148.2)	37,425 (166.5)	26,400 (117.4)	39,600 (176.2)
# 7 (22.2)	7-7/8 (200.0)	N/A	40,374 (179.6)	36,000 (160.1)	54,000 (240.2)
	10-1/2 (266.7)	38,975 (173.4)	46,050 (204.8)	36,000 (160.1)	54,000 (240.2)
# 8 (25.4)	9 (228.6)	35,600 (158.4)	47,311 (210.5)	47,400 (210.9)	71,100 (316.3)
	12 (304.8)	41,010 (182.4)	66,140 (294.2)	47,400 (210.9)	71,100 (316.3)
# 9 (28.6)	10-1/8 (257.2)	N/A	57,221 (254.5)	60,000 (266.9)	90,000 (400.4)
	13-1/2 (342.9)	N/A	79,966 (355.7)	60,000 (266.9)	90,000 (400.4)
# 10 (31.8)	11-1/4 (285.8)	49,045 (218.2)	73,091 (325.1)	76,200 (339.0)	114,300 (508.5)
	15 (381.0)	69,079 (307.3)	83,295 (370.5)	76,200 (339.0)	114,300 (508.5)
# 11 (34.9)	12-3/8 (314.3)	63,397 (282.0)	75,047 (333.8)	93,600 (416.4)	140,400 (624.6)
	16-1/2 (419.1)	81,707 (363.5)	91,989 (409.2)	93,600 (416.4)	140,400 (624.6)

1 Allowable working loads for the single installations under static loading should not exceed 25% capacity or the allowable load of the anchor rod.

2 Ultimate load values in 2000 and 4000 psi stone aggregate concrete. Ultimate loads are indicated for the embedment shown in the Embedment in Concrete column. Performance values are based on the use of minimum Grade 60 reinforcing bar. The use of lower strength rods will result in lower ultimate tension loads.

3 SHEAR DATA: Provided the distance from the rebar to the edge of the concrete member exceeds 1.25 times the embedment depth of the rebar, calculate the ultimate shear load for the rebar anchorage as 60% of the ultimate tensile strength of the rebar.



Call our toll free number 800-848-5611 or visit our web site for the most current product and technical information at www.itwredhead.com



PERFORMANCE TABLE

A7+
Quick-Cure Adhesive

Recommended Edge Distance Requirements for Shear Loads Installed in Solid Concrete

ANCHOR DIAMETER In. (mm)	EMBEDMENT DEPTH In. (mm)	CRITICAL EDGE DISTANCE In. (mm) (100% LOAD CAPACITY)	INTERPOLATED EDGE DISTANCE In. (mm) (80% LOAD CAPACITY)	INTERPOLATED EDGE DISTANCE In. (mm) (50% LOAD CAPACITY)	MINIMUM EDGE DISTANCE In. (mm) (10% LOAD CAPACITY)
3/8 (9.5)	3-3/8 (85.7)	4-3/16 (106.4)	3-7/16 (87.3)	2-5/16 (58.7)	13/16 (20.6)
1/2 (12.7)	4-1/2 (114.3)	5-5/8 (142.9)	4-5/8 (117.5)	3-1/8 (79.4)	1-1/8 (28.6)
5/8 (15.9)	5-5/8 (142.9)	7 (177.8)	5-3/4 (146.1)	3-1/8 (79.4)	1-3/8 (34.9)
3/4 (19.1)	6-3/4 (171.5)	8-7/16 (214.2)	6-15/16 (176.2)	4-5/8 (117.5)	1-5/8 (41.3)
1 (25.4)	9 (228.6)	11-1/4 (285.8)	9-1/4 (235.0)	6-1/4 (158.8)	2-1/4 (57.2)
1-1/4 (31.8)	11-1/4 (285.8)	14-1/16 (357.2)	11-5/8 (295.3)	7-7/8 (200.0)	2-7/8 (73.0)

PERFORMANCE TABLE

A7+
Quick-Cure Adhesive

Recommended Edge Distance Requirements for Tension Loads Installed in Solid Concrete

ANCHOR DIAMETER In. (mm)	EMBEDMENT DEPTH In. (mm)	CRITICAL EDGE DISTANCE In. (mm) (100% LOAD CAPACITY)	INTERPOLATED EDGE DISTANCE In. (mm) (90% LOAD CAPACITY)	INTERPOLATED EDGE DISTANCE In. (mm) (80% LOAD CAPACITY)	MINIMUM EDGE DISTANCE In. (mm) (70% LOAD CAPACITY)
3/8 (9.5)	3-3/8 (85.7)	2-1/2 (63.5)	1-15/16 (49.2)	1-3/8 (34.9)	13/16 (26.2)
	4-1/2 (114.3)	3-3/8 (85.7)	2-5/8 (66.7)	1-7/8 (47.6)	1-1/8 (28.6)
1/2 (12.7)	4-1/2 (114.3)	3-3/8 (85.7)	2-5/8 (66.7)	1-7/8 (47.6)	1-1/8 (28.6)
	6 (152.4)	4-1/2 (114.3)	3-1/2 (88.9)	2-1/2 (63.5)	1-1/2 (38.1)
5/8 (15.9)	5-5/8 (142.9)	4-3/16 (106.4)	3-1/4 (82.6)	2-5/16 (58.7)	1-3/8 (34.9)
	7-1/2 (190.5)	5-5/8 (142.9)	4-3/8 (111.1)	3-1/8 (79.4)	1-7/8 (47.6)
3/4 (19.1)	6-3/4 (171.5)	5-1/16 (128.6)	3-15/16 (100.0)	2-13/16 (71.4)	1-5/8 (15.9)
	9 (228.6)	6-3/4 (171.5)	5-1/4 (133.4)	3-3/4 (95.3)	2-1/4 (57.2)
1 (25.4)	9 (228.6)	6-3/4 (171.5)	5-1/4 (133.4)	3-3/4 (95.3)	2-1/4 (57.2)
	12 (304.8)	9 (228.6)	7 (177.8)	5 (127.0)	3 (76.2)
1-1/4 (31.8)	11-1/4 (285.8)	8-7/16 (214.3)	6-9/16 (166.7)	4-3/4 (120.7)	2-7/8 (73.0)
	15 (381.0)	11-1/4 (285.8)	8-3/4 (222.2)	6-1/4 (158.8)	3-3/4 (95.3)

A7+
Quick-Cure Adhesive

Allowable Stress Design Reference Tables

**A7+ Adhesive Edge/Spacing Distance Load Factor Summary
for Installation of Threaded Rod and Reinforcing Bar^{1,2}**

LOAD FACTOR	DISTANCE FROM EDGE OF CONCRETE
Critical Edge Distance—Tension	
100% Tension Load	→ 0.75 x Anchor Embedment
Minimum Edge Distance—Tension	
70% Tension Load	→ 0.25 x Anchor Embedment
Critical Edge Distance—Shear	
100% Shear Load	→ 1.25 x Anchor Embedment
Minimum Edge Distance—Shear	
10% Shear Load	→ 0.25 x Anchor Embedment
LOAD FACTOR	DISTANCE FROM ANOTHER ANCHOR
Critical Spacing—Tension	
100% Tension Load	→ 1.25 x Anchor Embedment
Minimum Spacing—Tension	
80% Tension Load	→ 0.25 x Anchor Embedment
Critical Spacing—Shear	
100% Shear Load	→ 1.25 x Anchor Embedment
Minimum Spacing—Shear	
25% Shear Load	→ 0.25 x Anchor Embedment

1 Use linear interpolation for load factors at edge distances or spacing distances between critical and minimum.

2 Anchors are affected by multiple combination of spacing and/or edge distance loading and direction of the loading. Use the product of tension and shear loading factors in design.

Combined Tension and Shear Loading—for A7+ Adhesive Anchors

Allowable loads for anchors under tension and shear loading at the same time (combined loading) will be lower than the allowable loads for anchors subjected to 100% tension or 100% shear. Use the following equation to evaluate anchors in combined loading conditions:

$$\left(\frac{Na}{Ns}\right)^{5/3} + \left(\frac{Va}{Vs}\right)^{5/3} \leq 1$$

Na = Applied Service Tension Load

Ns = Allowable Tension Load

Va = Applied Service Shear Load

Vs = Allowable Shear Load



STRENGTH DESIGN TABLE

A7+
Quick-Cure Adhesive

**Rebar- ASTM A615 Grade 60 Steel in Uncracked Concrete
- Tension (lbf) and Shear (lbf)**

Rebar	Anchor Diameter (in.)	Embedment Depth (in.)	Tension (lbf)					Shear (lbf)
			2500 psi	3000 psi	4000 psi	5000 psi	6000 - 8000 psi	2500 - 8000 psi
#3	3/8	3 3/8	3,663	3,663	3,663	3,663	3,663	3,564
		4 1/2	4,884	4,884	4,884	4,884	4,884	3,564
		7 1/2	6,435	6,435	6,435	6,435	6,435	3,564
#4	1/2	4 1/2	7,446	7,523	7,523	7,523	7,523	6,480
		6	10,030	10,030	10,030	10,030	10,030	6,480
		10	11,700	11,700	11,700	11,700	11,700	6,480
#5	5/8	5 5/8	10,406	11,399	11,542	11,542	11,542	10,044
		7 1/2	15,389	15,389	15,389	15,389	15,389	10,044
		12 1/2	18,135	18,135	18,135	18,135	18,135	10,044
#6	3/4	6 3/4	13,679	14,871	14,871	14,871	14,871	14,256
		9	19,827	19,827	19,827	19,827	19,827	14,256
		15	25,740	25,740	25,740	25,740	25,740	14,256
#7	7/8	7 7/8	17,237	18,883	19,467	19,467	19,467	19,440
		10 1/2	25,955	25,955	25,955	25,955	25,955	19,440
		17 1/2	35,100	35,100	35,100	35,100	35,100	19,440
#8	1	9	21,060	23,070	25,115	25,115	25,115	25,596
		12	32,424	33,486	33,486	33,486	33,486	25,596
		20	46,215	46,215	46,215	46,215	46,215	25,596
#9	1 1/8	10 3/16	25,363	27,638	31,472	31,472	31,472	32,400
		13 1/2	38,845	41,816	41,816	41,816	41,816	32,400
		22 9/16	58,500	58,500	58,500	58,500	58,500	32,400
#10	1 1/4	11 1/2	30,491	33,018	38,477	43,019	46,227	41,148
		15 1/4	46,406	50,835	58,699	61,261	61,261	41,148
		25 7/16	74,295	74,295	74,295	74,295	74,295	41,148

Tabulated values are for estimation purposes only and should not be used for design (please use our TruSpec anchorage design software at www.itwredhead.com)

Tabulated values represent design strengths per ACI 318 for a single anchor in adequate concrete thickness, not near an edge nor adjacent anchorage, not for sustained nor seismic loading

Bond strengths are for dry, cracked concrete with periodic inspection.

Bond strengths are for Temperature Range A (maximum long term temperature 110F, maximum short term temp 130F).

STRENGTH DESIGN TABLE

A7+
Quick-Cure Adhesive

Threaded Rod- ASTM A193 B7 in Uncracked Concrete

Anchor Diameter (in.)	Embedment Depth (in.)	Tension (lbf)					Shear (lbf)
		2500 psi	3000 psi	4000 psi	5000 psi	6000 psi - 8000 psi	2500 psi - 8000 psi
3/8	3 3/8	3,871	3,871	3,871	3,871	3,871	3,777
	4 1/2	5,161	5,161	5,161	5,161	5,161	3,777
	7 1/2	7,268	7,268	7,268	7,268	7,268	3,777
1/2	4 1/2	6,881	6,881	6,881	6,881	6,881	6,916
	6	9,175	9,175	9,175	9,175	9,175	6,916
	10	13,305	13,305	13,305	13,305	13,305	6,916
5/8	5 5/8	10,406	10,406	10,406	10,406	10,406	11,018
	7 1/2	14,336	14,336	14,336	14,336	14,336	11,018
	12 1/2	21,188	21,188	21,188	21,188	21,188	11,018
3/4	6 3/4	13,679	14,984	14,984	14,984	15,483	16,309
	9	20,644	20,644	20,644	20,644	20,644	16,309
	15	31,358	31,358	31,358	31,358	31,358	16,309
7/8	7 7/8	17,237	17,740	17,740	17,740	17,740	22,510
	10 1/2	23,654	23,654	23,654	23,654	23,654	22,510
	17 1/2	39,423	39,423	39,423	39,423	39,423	22,510
1	9	21,060	23,070	23,070	23,070	23,171	29,530
	12	30,894	30,894	30,894	30,894	30,894	29,530
	20	51,491	51,491	51,491	51,491	51,491	29,530
1 1/4	11 1/2	30,419	33,322	38,477	43,019	43,738	47,242
	15 1/4	46,406	50,835	57,962	57,962	57,962	47,242
	25 7/16	90,855	90,855	90,855	90,855	90,855	47,242

Tabulated values are for estimation purposes only and should not be used for design (please use our TruSpec anchorage design software at www.itwredhead.com)

Tabulated values represent design strengths per ACI 318 for a single anchor in adequate concrete thickness, not near an edge nor adjacent anchorage, not for sustained nor seismic loading
Bond strengths are for dry, cracked concrete with periodic inspection.

Bond strengths are for Temperature Range A (maximum long term temperature 110F, maximum short term temp 130F).

STRENGTH DESIGN TABLE

A7+
Quick-Cure Adhesive

**Threaded Rod in 2,500 - 8,000 psi
Uncracked Concrete - Tension (lbf) and Shear (lbf)**

Anchor Diameter (in.)	Embedment Depth (in.)	Carbon Steel A36		Stainless Steel F593		ASTM A193 B7 Threaded Rod	
		Tension (lbf)	Shear (lbf)	Tension (lbf)	Shear (lbf)	Tension (lbf)	Shear (lbf)
3/8	3 3/8	3,375	1,755	3,871	2,280	3,871	3,777
	4 1/2	3,375	1,755	4,787	2,280	5,161	3,777
	7 1/2	3,375	1,755	4,787	2,280	7,268	3,777
1/2	4 1/2	6,173	3,211	6,881	4,044	6,881	6,916
	6	6,173	3,211	8,762	4,044	9,175	6,916
	10	6,173	3,211	8,762	4,044	13,305	6,916
5/8	5 5/8	9,833	5,116	10,752	6,441	10,752	11,018
	7 1/2	9,833	5,116	13,956	6,441	14,336	11,018
	12 1/2	9,833	5,116	13,956	6,441	21,188	11,018
3/4	6 3/4	14,550	7,566	15,483	7,614	15,483	16,309
	9	14,550	7,566	16,500	7,614	20,644	16,309
	15	14,550	7,566	16,500	7,614	31,358	16,309
7/8	7 7/8	17,740	10,446	17,740	10,533	17,740	22,510
	10 1/2	20,085	10,446	22,822	10,533	23,654	22,510
	17 1/2	20,085	10,446	22,822	10,533	39,423	22,510
1	9	23,171	13,702	23,171	13,818	23,171	29,530
	12	26,348	13,702	29,936	13,818	30,894	29,530
	20	26,348	13,702	29,936	13,818	51,491	29,530
1 1/4	11 1/2	38,477	21,925	38,477	22,092	38,477	47,242
	15 1/4	42,158	21,925	47,869	22,092	57,049	47,242
	25 7/16	42,158	21,925	47,869	22,092	90,855	47,242

Tabulated values are for estimation purposes only and should not be used for design (please use our TruSpec anchorage design software at www.itwredhead.com)

Tabulated values represent design strengths per ACI 318 for a single anchor in adequate concrete thickness, not near an edge nor adjacent anchorage, not for sustained nor seismic loading
Bond strengths are for dry, cracked concrete with periodic inspection.

Bond strengths are for Temperature Range A (maximum long term temperature 110F, maximum short term temp 130F).

STRENGTH DESIGN TABLE

A7+
Quick-Cure Adhesive

**Rebar- ASTM A615 Grade 60 Steel in Cracked Concrete -
Tension (lbf) and Shear (lbf)**

Rebar	Anchor Diameter (in.)	Embedment Depth (in.)	Tension (lbf) 2500 - 8000 psi concrete	Shear (lbf) 2500 - 8000 psi concrete
#3	3/8	3 3/8	1,651	2,311
		4 1/2	2,201	3,082
		7 1/2	3,669	3,564
#4	1/2	4 1/2	2,935	4,109
		6	3,914	5,479
		10	6,523	6,480
#5	5/8	5 5/8	4,586	6,421
		7 1/2	6,115	8,561
		12 1/2	10,192	10,044
#6	3/4	6 3/4	5,117	7,164
		9	6,823	9,552
		15	11,372	14,256
#7	7/8	7 7/8	6,965	9,751
		10 1/2	9,287	13,002
		17 1/2	15,478	19,440
#8	1	9	9,097	12,736
		12	12,130	16,982
		20	20,216	25,596
#9	1 1/8	10 3/16	11,616	16,262
		13 1/2	15,434	21,607
		22 9/16	25,726	32,400
#10	1 1/4	11 1/2	17,447	24,426
		15 1/4	23,121	32,369
		25 7/16	38,592	41,148

Tabulated values are for estimation purposes only and should not be used for design (please use our TruSpec anchorage design software at www.itwredhead.com)

Tabulated values represent design strengths per ACI 318 for a single anchor in adequate concrete thickness, not near an edge nor adjacent anchorage, not for sustained nor seismic loading

Bond strengths are for dry, cracked concrete with periodic inspection.

Bond strengths are for Temperature Range A (maximum long term temperature 110F, maximum short term temp 130F).

STRENGTH DESIGN TABLE

A7+
Quick-Cure Adhesive

**Threaded Rod in 2,500 - 8,000 psi Cracked Concrete -
Tension (lbf) and Shear (lbf)**

Anchor Diameter (in.)	Embedment Depth (in.)	Tension (lbf)	Shear (lbf)		
			Carbon Steel A36	Stainless Steel F593	ASTM A193 B7 Threaded Rod
3/8	3 3/8	2,318	1,755	2,280	3,245
	4 1/2	3,091	1,755	2,280	3,777
	7 1/2	5,151	1,755	2,280	3,777
1/2	4 1/2	3,071	3,211	4,044	4,300
	6	4,095	3,211	4,044	5,733
	10	6,825	3,211	4,044	6,916
5/8	5 5/8	5,224	5,116	6,441	7,314
	7 1/2	6,965	5,116	6,441	9,752
	12 1/2	11,609	5,116	6,441	11,018
3/4	6 3/4	7,785	7,566	7,614	10,899
	9	10,380	7,566	7,614	14,532
	15	17,300	7,566	7,614	16,309
7/8	7 7/8	8,275	10,446	10,533	11,585
	10 1/2	11,033	10,446	10,533	15,446
	17 1/2	18,388	10,446	10,533	22,510
1	9	10,186	13,702	13,818	14,260
	12	13,581	13,702	13,818	19,014
	20	22,635	13,702	13,818	29,530
1 1/4	11 1/2	17,172	21,925	22,092	24,041
	15 1/4	22,757	21,925	22,092	31,860
	25 7/16	37,984	21,925	22,092	47,242

Tabulated values are for estimation purposes only and should not be used for design (please use our TruSpec anchorage design software at www.itwredhead.com)

Tabulated values represent design strengths per ACI 318 for a single anchor in adequate concrete thickness, not near an edge nor adjacent anchorage, not for sustained nor seismic loading
Bond strengths are for dry, cracked concrete with periodic inspection.

Bond strengths are for Temperature Range A (maximum long term temperature 110F, maximum short term temp 130F).

MASONRY DESIGN TABLE

A7+ Quick-Cure Adhesive

Grout-filled Concrete Block: Allowable Tension and Shear Loads based on Steel Design Information for U.S. Customary Unit Threaded Rod ^{1, 2, 3}

Anchor Diameter (in.)	Tension (lb)			Shear (lb)		
	ASTM A307 F _u = 60 ksi	ASTM A193 Grade B7 F _u = 125 ksi	ASTM F593 SS 304 F _u = 100 ksi	ASTM A307 F _u = 60 ksi	ASTM A193 Grade B7 F _u = 125 ksi	ASTM F593 SS 304 F _u = 100 ksi
3/8	2,185	4,555	3,645	1,125	2,345	1,875
1/2	3,885	8,100	6,480	2,000	4,170	3,335
5/8	6,075	12,655	10,125	3,130	6,520	5,215
3/4	8,750	18,225	12,390	4,505	9,390	6,385

For SI: 1 inch = 25.4mm, 1 lbf = 4.45N, 1ft-lbf = 1.356 N-M, 1 psi = 0.006895 MPa

¹Allowable load used in the design must be the lesser of bond values and tabulated steel element values.

²Allowable tension and shear loads for threaded rods to resist short term loads, such as wind or seismic, must be calculated in accordance with Section 4.1 as applicable.

³Allowable steel loads are based on allowable tension and shear stresses equal to 0.33X F_u and 0.17X F_u, respectively.

MASONRY DESIGN TABLE

A7+ Quick-Cure Adhesive

Grout-filled Concrete Block: Allowable Tension Loads for Threaded Rod ^{1, 2, 3, 4, 7, 9, 10, 11, 12}

Anchor Diameter (in.)	Minimum Embedment (inches)	Load at s _{cr} and c _{cr} (lb)	Spacing ⁵			Edge Distance ⁶		
			Critical s _{cr} (inches)	Minimum s _{min} (inches)	Load reduction factor for s _{min} ⁸	Critical c _{cr} (inches)	Minimum c _{min} (inches)	Load reduction factor for c _{min} ⁸
3/8	3 ¾	1,125	13.5	4	1.00	12	4	1.00
1/2	4 ½	1,695	18	4	0.60	20	4	0.90
5/8	5 ¾	2,015	22.5	4	0.60	20	4	0.90
3/4	6 ¾	3,145	27	4	0.60	20	4	0.63

MASONRY DESIGN TABLE

A7+ Quick-Cure Adhesive

Grout-filled Concrete Block: Allowable Shear Loads for Threaded Rod ^{1, 2, 3, 4, 7, 9, 10, 11, 12}

Anchor Diameter (in.)	Minimum Embedment (inches)	Load at s _{cr} and c _{cr} (lb)	Spacing ⁵			Edge Distance ⁶		
			Critical s _{cr} (inches)	Minimum s _{min} (inches)	Load reduction factor for s _{min} ⁸	Critical c _{cr} (inches)	Minimum c _{min} (inches)	Load reduction factor for c _{min} ⁸
3/8	3 ¾	750	13.5	4	0.50	12	4	0.95
1/2	4 ½	1,520	18	4	0.50	20	4	0.44
5/8	5 ¾	2,285	22.5	4	0.50	12	4	0.26
3/4	6 ¾	2,345	27	4	0.50	20	4	0.26

For SI: 1 inch = 25.4mm, 1 lbf = 0.0044 kN, 1 ksi = 6.894 MPa. (Refer to Table 4 for footnotes)

¹All values are for anchors installed in fully grouted concrete masonry with minimum masonry strength of 1500 psi (10.3 MPa). Concrete masonry units must be light-, medium-, or normal-weight conforming to ASTM C 90. Allowable loads have been calculated using a safety factor of 5.0.

³Anchors may be installed in any location in the face of the masonry wall (cell, web, bed joint) as shown in Figure 2.

⁴A maximum of two anchors may be installed in a single masonry cell in accordance with the spacing and edge or end distance requirements. Embedment is measured from the outside surface of the concrete masonry unit to the embedded end of the anchor. See Figure 2 of this report.

⁵The critical spacing distance, s_{cr}, is the anchor spacing where full load values in the table may be used. The minimum spacing distance, s_{min}, is the minimum anchor spacing for which values are available and installation is permitted. Spacing distance is measured from the centerline to centerline between two anchors.

⁶The critical edge or end distance, c_{cr}, is the distance where full load values in the table may be used. The minimum edge or end distance, c_{min}, is the minimum distance for which values are available and installation is permitted. Edge or end distance is measured from anchor centerline to the closest unrestrained edge.

⁷The tabulated values are applicable for anchors in the ends of grout-filled concrete masonry units where minimum edge distances are maintained.

⁸Load values for anchors installed less than s_{cr} and c_{cr} must be multiplied by the appropriate load reduction factor based on actual spacing (s) or edge distance (c). Load factors are multiplicative; both spacing and edge reduction factors must be considered.

⁹Linear interpolation of load values between minimum spacing (s_{min}) and critical spacing (s_{cr}) and between minimum edge or end distance (c_{min}) and critical edge or end distance (c_{cr}) is permitted.

¹⁰Concrete masonry width (wall thickness) must be equal to or greater than 1.5 times the anchor embedment depth (e.g. 3/8-inch- and 1/2-inch-diameter anchors are permitted in minimum nominally 6-inch-thick concrete masonry). The 5/8- and 3/4-inch-diameter anchors must be installed in minimum nominally 8-inch-thick concrete masonry.

¹¹Allowable loads must be the lesser of the adjusted masonry or bond values tabulated above and the steel strength values given in Table 2.

¹²Tabulated allowable bond loads must be adjusted for increased in-service base material temperatures in accordance with Figure 1, as applicable.

MASONRY DESIGN TABLE

A7+
Quick-Cure Adhesive

Grout-filled Concrete Block: Allowable Tension and Shear Loads for Rebar ^{1, 2, 3}

Rebar Size	Tension (lb)	Shear (lb)
	ASTM A615, Grade 60	ASTM A615, Grade 60
No. 3	3,270	1,685
No. 4	5,940	3,060
No. 5	9,205	4,745
No. 6	13,070	6,730

For SI: 1 inch = 25.4mm, 1 lbf = 4.45N, 1ft-lbf = 1.356 N-M, 1 psi = 0.006895 MPa

1 Allowable load used in the design must be the lesser of bond values and tabulated steel element values.

2 Allowable tension and shear loads for threaded rods to resist short term loads, such as wind or seismic, must be calculated in accordance with Section 4.1 as applicable.

3 Allowable steel loads are based on allowable tension and shear stresses equal to 0.33X Fu and 0.17XFu, respectively.

MASONRY DESIGN TABLE

A7+
Quick-Cure Adhesive

Grout-filled Concrete Block: Allowable Tension Loads for Rebar ^{1, 2, 3, 4, 7, 9, 10, 11, 12}

Anchor Diameter (in.)	Minimum Embedment (inches)	Load at s_{cr} and c_{cr} (lb)	Spacing ⁵			Edge Distance ⁶		
			Critical s_{cr} (inches)	Minimum s_{min} (inches)	Load reduction factor for s_{min} ⁸	Critical c_{cr} (inches)	Minimum c_{min} (inches)	Load reduction factor for c_{min} ⁸
3/8	3 3/8	1,530	13.5	4	1.00	12	4	1.00
1/2	4 1/2	1,845	18	4	0.60	20	4	0.90
5/8	5 5/8	2,465	22.5	4	0.60	20	4	0.90
3/4	6 3/4	2,380	27	4	0.60	20	4	0.63

MASONRY DESIGN TABLE

A7+
Quick-Cure Adhesive

Grout-filled Concrete Block: Allowable Shear Loads for Rebar ^{1, 2, 3, 4, 7, 9, 10, 11, 12}

Anchor Diameter (in.)	Minimum Embedment (inches)	Load at s_{cr} and c_{cr} \perp to edge (lb)	Spacing ⁵			Edge Distance ⁶		
			Critical s_{cr} (inches)	Minimum s_{min} (inches)	Load reduction factor for s_{min} ⁸	Critical c_{cr} (inches)	Minimum c_{min} (inches)	Load reduction factor for c_{min} ⁸
3/8	3 3/8	1,410	13.5	4	0.50	12	4	0.95
1/2	4 1/2	1,680	18	4	0.50	20	4	0.44
5/8	5 5/8	3,245	22.5	4	0.50	12	4	0.26
3/4	6 3/4	4,000	27	4	0.50	20	4	0.26

For SI: 1 inch = 25.4 mm; 1 lbf = 0.0044 kN, 1 ksi = 6.894 MPa.

(The following footnotes apply to both Tables 6 and 7)

1 All values are for anchors installed in fully grouted concrete masonry with minimum masonry strength of 1500 psi (10.3 MPa). Concrete masonry units must be light-, medium, or normal-weight conforming to ASTM C 90. Allowable loads have been calculated using a safety factor of 5.0.

3 Anchors may be installed in any location in the face of the masonry wall (cell, web, bed joint) as shown in figure 2.

4 A maximum of two anchors may be installed in a single masonry cell in accordance with the spacing and edge or end distance requirements. Embedment is measured from the outside surface of the concrete masonry unit to the embedded end of the anchor. See Figure 2 of this report.

5 The critical spacing distance, s_{cr} , is the anchor spacing where full load values in the table may be used. The minimum spacing distance, s_{min} , is the minimum anchor spacing for which values are available and installation is permitted. Spacing distance is measured from the centerline to centerline between two anchors.

6 The critical edge or end distance, c_{cr} , is the distance where full load values in the table may be used. The minimum edge or end distance, c_{min} , is the minimum distance for which values are available and installation is permitted. Edge or end distance is measured from anchor centerline to the closest unrestrained edge.

7 The tabulated values are applicable for anchors in the ends of grout-filled concrete masonry units where minimum edge distances are maintained.

8 Load values for anchors installed less than s_{cr} and c_{cr} must be multiplied by the appropriate load reduction factor based on actual spacing (s) or edge distance (c). Load factors are multiplicative; both spacing and edge reduction factors must be considered.

9 Linear interpolation of load values between minimum spacing (s_{min}) and critical spacing (s_{cr}) and between minimum edge or end distance (c_{min}) and critical edge or end distance (c_{cr}) is permitted.

10 Concrete masonry width (wall thickness) must be equal to or greater than 1.5 times the anchor embedment depth (e.g. No. 3 and No. 4 reinforcing bars are permitted in minimum nominally 6-inch-thick concrete masonry). No. 5 and No. 6 reinforcing bars must be installed in minimum nominally 8-inch-thick concrete masonry.

11 Allowable loads must be the lesser of the adjusted masonry or bond values tabulated above and the steel strength values given in Table 4.

12 Tabulated allowable bond loads must be adjusted for increased in-service base material temperatures in accordance with Figure 1, as applicable.



Most Widely Accepted and Trusted

ICC-ES Report

ESR-3903

ICC-ES | (800) 423-6587 | (562) 699-0543 | www.icc-es.org

Issued 12/2016
This report is subject to renewal 12/2017.

DIVISION: DIVISION: 03 00 00—CONCRETE
SECTION: 03 16 00—CONCRETE ANCHORS
DIVISION: DIVISION: 05 00 00—METALS
SECTION: 05 05 19—POST-INSTALLED CONCRETE ANCHORS

REPORT HOLDER:

ITW RED HEAD

**700 HIGH GROVE BOULEVARD
GLENDALE HEIGHTS, ILLINOIS 60139**

EVALUATION SUBJECT:

**ITW RED HEAD A7+ ADHESIVE ANCHORING SYSTEM
FOR CRACKED AND UNCRACKED CONCRETE**



Look for the trusted marks of Conformity!

“2014 Recipient of Prestigious Western States Seismic Policy Council (WSSPC) Award in Excellence”



ICC-ES Evaluation Reports are not to be construed as representing aesthetics or any other attributes not specifically addressed, nor are they to be construed as an endorsement of the subject of the report or a recommendation for its use. There is no warranty by ICC Evaluation Service, LLC, express or implied, as to any finding or other matter in this report, or as to any product covered by the report.



ICC-ES Evaluation Report

ESR-3903

Issued December 2016

Corrected December 5, 2016

This report is subject to renewal December 2017.

www.icc-es.org | (800) 423-6587 | (562) 699-0543

A Subsidiary of the International Code Council®

DIVISION: 03 00 00—CONCRETE
Section: 03 16 00—Concrete Anchors

DIVISION: 05 00 00—METALS
Section: 05 05 19—Post-Installed Concrete Anchors

REPORT HOLDER:

ITW RED HEAD
700 HIGH GROVE BOULEVARD
GLENDALE HEIGHTS, ILLINOIS 60139
(800) 848-5611
www.itw-redhead.com
techsupport@itwccna.com

EVALUATION SUBJECT:

**ITW RED HEAD A7+ ADHESIVE ANCHORING SYSTEM
FOR CRACKED AND UNCRACKED CONCRETE**

1.0 EVALUATION SCOPE

Compliance with the following codes:

- 2015, 2012, 2009, 2006 and 2003 *International Building Code*® (IBC)
- 2015, 2012, 2009, 2006 and 2003 *International Residential Code*® (IRC)
- 2013 *Abu Dhabi International Building Code* (ADIBC)[†]

[†]The ADIBC is based on the 2009 IBC. 2009 IBC code sections referenced in this report are the same sections in the ADIBC.

Property evaluated:

Structural

2.0 USES

The Red Head A7+ Adhesive Anchoring System is a post-installed anchorage system used to resist static, wind or earthquake (Seismic Design Categories A through F) tension and shear loads in cracked and uncracked normal-weight concrete having a specified compressive strength, f'_c , of 2500 psi to 8,500 psi (17.2 MPa to 58.6 MPa) [minimum of 24 MPa is required under ADIBC Appendix L, Section 5.1.1].

The anchoring system complies with anchors as described in Section 1901.3 of the 2015 IBC, Section 1909 of the 2012 IBC and is an alternative to cast-in-place anchors described in Section 1908 of the 2012 IBC, and Sections 1911 and 1912 of the 2009 and 2006 IBC, and Sections 1912 and 1913 of the 2003 IBC. The anchoring

system may also be used where an engineered design is submitted in accordance with Section R301.1.3 of the IRC.

3.0 DESCRIPTION

3.1 General:

The Red Head Epcon A7+ Adhesive Anchoring System is a two-component, high-strength, fast-cure, structural adhesive, used with continuously threaded rods and deformed reinforcing bar installed in normal-weight concrete. The primary components of the ITW Red Head A7+ Adhesive Anchoring System are shown in Figure 1 of this report.

The manufacturer's printed installation instructions (MPII) are included with the adhesive packaging and are replicated in Figure 3 of this report.

3.2 Materials:

3.2.1 Adhesive: The Red Head A7+ Anchoring System is a two-part vinylester packaged in a dual-chamber cartridge at a volumetric ratio of 10:1. The cartridge is available in 28-ounce (side-by-side), 9.5-ounce (coaxial), and 5-ounce (coaxial) sizes. The components are dispensed through a static mixing nozzle which attaches to the cartridge. The original, unopened cartridge has a shelf life of 18 months, as indicated by the "best used by" date stamped onto the cartridge, when stored in a cool, dry, ventilated area and in accordance with Figure 3.

3.2.2 Hole Cleaning Equipment: Hole cleaning equipment consists of wire brushes, as shown in Figures 1 and 3, and a compressed air nozzle with extension.

3.2.3 Dispensing Tools: Red Head A7+ Adhesive must be dispensed with manual or pneumatic dispensing tools provided by ITW Red Head, as shown in Figure 1.

3.2.4 Anchor Elements:

3.2.4.1 Threaded Rods: The continuously threaded rods range from $\frac{3}{8}$ inch through $1\frac{1}{4}$ inches (9.5 mm through 31.75 mm) in diameter. Carbon steel threaded rods must comply with either ASTM A36 [minimum f_{uta} = 58,000 psi (400 MPa)] or ASTM A193, Grade B7 [minimum f_{uta} = 125,000 psi (860 MPa)]. Stainless steel threaded rods must comply with ASTM F593 (Alloy Type 300, CW1 and CW2) [minimum f_{uta} = 95,000 psi (655 MPa) for CW1, and f_{uta} = 80,000 psi (552 MPa) for CW2]. Table 1 notes steel design information for the threaded rods. Carbon steel threaded rods must be furnished with a minimum 0.0002-inch-thick (5 μ m) zinc electroplated coating complying with ASTM B633 SC1 or must be hot-dipped galvanized complying with ASTM A153, Class C or D.

Threaded steel rods must be straight and free from indentations or other defects along their length.

3.2.4.2 Steel Reinforcing Bars: Steel reinforcing bars are deformed reinforcing bars as described in Table 4 of this report. The embedded portions of reinforcing bars must be straight, and free of mill scale, rust, mud, oil, and other coatings that may impair the bond with the adhesive. Reinforcing bars must not be bent after installation, except as set forth in ACI 318-14 Section 26.6.3.1 (b) or ACI 318-11 Section 7.3.2, as applicable, with the additional condition that the bars must be bent cold, and heating of reinforcing bars to facilitate field bending is not permitted.

3.2.4.3 Ductility: In accordance with ACI 318-14 2.3 or ACI 318-11 D.1, as applicable, in order for a steel element to be considered ductile, the tested elongation must be at least 14 percent and reduction of area must be at least 30 percent. Steel elements with a tested elongation of less than 14 percent or a reduction of area of less than 30 percent, or both, are considered brittle. Where values are nonconforming or unstated, the steel must be considered brittle.

3.3 Concrete:

Normal-weight concrete must comply with Sections 1903 and 1905 of the IBC. The specified compressive strength of the concrete must be from 2,500 psi to 8,500 psi (17.2 MPa to 58.6 MPa) [minimum of 24 MPa is required under ADIBC Appendix L, Section 5.1.1].

4.0 DESIGN AND INSTALLATION

4.1 Strength Design:

4.1.1 General: The design strength of anchors under the 2015 IBC, as well as the 2015 IRC must be determined in accordance with ACI 318-14 and this report. The design strength of anchors under the 2012, 2009, 2006 and 2003 IBC, as well as the 2012, 2009, 2006 and 2003 IRC, must be determined in accordance with ACI 318-11 and this report.

A design example in accordance with the 2012 IBC based on ACI 318-11 is provided in Figure 2 of this report.

Design parameters are based on ACI 318-14 for use with the 2015 IBC, and the ACI 318-11 for use with the 2012, 2009, 2006 and 2003 IBC unless noted otherwise in this report.

The strength design of anchors must comply with ACI 318-14 17.3.1 or ACI 318-11 D.4.1, as applicable, except as required in ACI 318-14 17.2.3 or ACI 318-11 D.3.3, as applicable. Design parameters are provided in Tables 1 through 6. Strength reduction factors, ϕ , as given in ACI 318-14 17.3.3 or ACI 318-11 D.4.3, as applicable, must be used for load combinations calculated in accordance with Section 1605.2 of the IBC or ACI 318-14 5.3 or ACI 318-11 9.2, as applicable. Strength reduction factors, ϕ , as described in ACI 318-11 D.4.4, must be used for load combinations calculated in accordance with ACI 318-11 Appendix C.

4.1.2 Static Steel Strength in Tension: The nominal static steel strength of a single anchor in tension, N_{sa} , in accordance with ACI 318-14 17.4.1.2 or ACI 318-11 D.5.1.2, as applicable, and the associated strength reduction factors, ϕ , in accordance with ACI 318-14 17.3.3 or ACI 318-11 D.4.3, as applicable, are given in Tables 1 and 4 of this report for the anchor element types included in this report.

4.1.3 Static Concrete Breakout Strength in Tension: The nominal static concrete breakout strength of a single anchor or group of anchors in tension, N_{cb} or N_{cbg} , must be

calculated in accordance with ACI 318-14 17.4.2 or ACI 318-11 D.5.2, as applicable, with the following addition:

The basic concrete breakout strength of a single anchor in tension, N_b , must be calculated in accordance with ACI 318-14 17.4.2.2 or ACI 318-11 D.5.2.2, as applicable, using the values of $k_{c,cr}$, and $k_{c,uncr}$ as described in Tables 2 and 5 of this report. Where analysis indicates no cracking in accordance with ACI 318-14 17.4.2.6 or ACI 318-11 D.5.2.6, as applicable, N_b must be calculated using $k_{c,uncr}$ and $\Psi_{c,N} = 1.0$. For anchors in lightweight concrete see ACI 318-14 17.2.6 or ACI 318-11 D.3.6, as applicable. The value of f'_c used for calculation must be limited to 8,000 psi (55 MPa) in accordance with ACI 318-14 17.2.7 or ACI 318-11 D.3.7, as applicable. Additional information for the determination of nominal bond strength in tension is given in Section 4.1.4 of this report.

4.1.4 Static Bond Strength in Tension: The nominal static bond strength of a single adhesive anchor or group of adhesive anchors in tension, N_a or N_{ag} , must be calculated in accordance with ACI 318-14 17.4.5 or ACI 318-11 D.5.5, as applicable. Bond strength values are a function of whether the concrete is cracked or uncracked, the concrete temperature range, the installation conditions (dry or water-saturated concrete, water-filled holes, or submerged), and the level of inspection provided. The resulting characteristic bond strength shall be multiplied by the associated strength reduction factor ϕ_{nn} as follows:

CONCRETE TYPE	PERMISSIBLE INSTALLATION CONDITIONS	BOND STRENGTH	ASSOCIATED STRENGTH REDUCTION FACTOR
Uncracked	Dry	τ_{uncr}	ϕ_d
	Water-saturated	τ_{uncr}	ϕ_{ws}
	Water-filled holes	τ_{uncr}	ϕ_{vrf}
	Submerged	τ_{uncr}	ϕ_{sub}
Cracked	Dry	τ_{cr}	ϕ_d
	Water-saturated	τ_{cr}	ϕ_{ws}
	Water-filled holes	τ_{cr}	ϕ_{vrf}
	Submerged	τ_{cr}	ϕ_{sub}

Strength reduction factors for determination of the bond strength are given in Tables 3 and 6 of this report.

4.1.5 Static Steel Strength in Shear: The nominal static strength of a single anchor in shear as governed by the steel, V_{sa} , in accordance with ACI 318-14 17.5.1.2 or ACI 318-11 D.6.1.2, as applicable, and strength reduction factors, ϕ , in accordance with ACI 318-14 17.2.3 or ACI 318-11 D.4.3, as applicable are given in Tables 1 and 4 of this report for the anchor element types included in this report.

4.1.6 Static Concrete Breakout Strength in Shear: The nominal concrete breakout strength of a single anchor or group of anchors in shear, V_{cb} or V_{cbg} , must be calculated in accordance with ACI 318-14 17.5.2 or ACI 318-11 D.6.2, as applicable, based on information given in Table 2 and Table 5 of this report. The basic concrete breakout strength of a single anchor in shear, V_b , must be calculated in accordance with ACI 318-14 17.5.2.2 or ACI 318-11 D.6.2.2, as applicable, using the values of d given in this report in lieu of d_a (2015, 2012 and 2009 IBC), d_o (2006 IBC). In addition, h_{ef} shall be substituted for ℓ_e . In no case shall ℓ_e exceed $8d$. The value of f'_c must be limited to a

maximum value of 8,000 psi (55 MPa) in accordance with ACI 318-14 17.2.7 or ACI 318-11 D.3.7, as applicable.

4.1.7 Static Concrete Pryout Strength in Shear: The nominal static pryout strength of a single anchor or group of anchors in shear, V_{cp} or $V_{cp,g}$, shall be calculated in accordance with ACI 318-14 17.5.3 or ACI 318-11 D.6.3, as applicable.

4.1.8 Interaction of Tensile and Shear Forces: For designs that include combined tension and shear, the interaction of tension and shear loads must be calculated in accordance with ACI 318-14 17.6 or ACI 318-11 D.7, as applicable.

4.1.9 Minimum Member Thickness, h_{min} , Anchor Spacing, s_{min} , and Edge Distance, c_{min} : In lieu of ACI 318-14 17.7.1 and 17.7.3 or ACI 318-11 D.8.1 and D.8.3, as applicable, values of s_{min} and c_{min} , as given in Table 2 and Table 5 of this report, must be observed for anchor design and installation. The minimum member thicknesses h_{min} , as given in Table 2 and Table 5 of this report must be observed for anchor design and installation. For adhesive anchors that will remain untorqued, ACI 318-14 17.7.4 or ACI 318-11 D.8.4, as applicable, applies.

4.1.10 Critical Edge Distance c_{ac} and $\psi_{cp,Na}$: The modification factor $\psi_{cp,Na}$, must be determined in accordance with ACI 318-14 17.4.5.5 or ACI 318-11 D.5.5.5, as applicable, except as noted below:

For all cases where $c_{Na}/c_{ac} < 1.0$, $\psi_{cp,Na}$ determined from ACI 318-14 Eq. 17.4.5.5b or ACI 318-11 Eq. D-27, as applicable, need not be taken less than c_{Na}/c_{ac} . For all other cases, $\psi_{cp,Na}$ shall be taken as 1.0.

The critical edge distance, c_{ac} must be calculated according to Eq. 17.4.5.5c for ACI 318-14 or Eq. D-27a for ACI 318-11, in lieu of ACI 318-14 17.7.6 or ACI 318-11 D.8.6, as applicable.

$$c_{ac} = h_{ef} \left(\frac{\tau_{k,uncr}}{1160} \right)^{0.4} \cdot \left[3.1 - 0.7 \frac{h}{h_{ef}} \right]$$

(Eq. 17.4.5.5c for ACI 318-14 or Eq. D-27a for ACI 318-11)

where

$\left[\frac{h}{h_{ef}} \right]$ need not be taken as larger than 2.4; and

$\tau_{k,uncr}$ = the characteristic bond strength stated in the tables of this report whereby $\tau_{k,uncr}$ need not be taken as larger than:

$$\tau_{uncr} = \frac{k_{uncr} \sqrt{h_{ef} f'_c}}{\pi \cdot d_a} \quad \text{Eq. (4-1)}$$

4.1.11 Design Strength in Seismic Design Categories C, D, E and F: In structures assigned to Seismic Design Category C, D, E or F under the IBC or IRC, anchors must be designed in accordance with ACI 318-14 17.2.3 or ACI 318-11 D.3.3, as applicable, except as described below. Modifications to ACI 318-14 17.2.3 shall be applied under Section 1905.1.8 of the 2015 IBC. For the 2012 IBC, Section 1905.1.9 shall be omitted. The nominal steel shear strength, V_{sa} , must be adjusted by $\alpha_{V,seis}$ as given in Tables 1 and 4 for the anchor element types included in this report. The nominal bond strength $\tau_{k,cr}$ must be adjusted by $\alpha_{N,seis}$, as given in Tables 3 and 6 of this report.

As an exception to ACI 318-11 D.3.3.4.2: Anchors designed to resist wall out-of-plane forces with design strengths equal to or greater than the force determined in accordance with ASCE 7 Equation 12.11-1 or 12.14-10 shall be deemed to satisfy ACI 318-11 D.3.3.4.3(d).

Under ACI 318-11 D.3.3.4.3(d), in lieu of requiring the anchor design tensile strength to satisfy the tensile strength requirements of ACI 318-11 D.4.1.1, the anchor design tensile strength shall be calculated from ACI 318-11 D.3.3.4.4.

The following exceptions apply to ACI 318-11 D.3.3.5.2:

1. For the calculation of the in-plane shear strength of anchor bolts attaching wood sill plates of bearing or non-bearing walls of light-frame wood structures to foundations or foundation stem walls, the in-plane shear strength in accordance with ACI 318-11 D.6.2 and D.6.3 need not be computed and ACI 318-11 D.3.3.5.3 need not apply provided all of the following are satisfied:

1.1. The allowable in-plane shear strength of the anchor is determined in accordance with AF&PA NDS Table 11E for lateral design values parallel to grain.

1.2. The maximum anchor nominal diameter is $5/8$ inch (16 mm).

1.3. Anchor bolts are embedded into concrete a minimum of 7 inches (178 mm).

1.4. Anchor bolts are located a minimum of $1^{3/4}$ inches (45 mm) from the edge of the concrete parallel to the length of the wood sill plate.

1.5. Anchor bolts are located a minimum of 15 anchor diameters from the edge of the concrete perpendicular to the length of the wood sill plate.

1.6. The sill plate is 2-inch or 3-inch nominal thickness.

2. For the calculation of the in-plane shear strength of anchor bolts attaching cold-formed steel track of bearing or non-bearing walls of light-frame construction to foundations or foundation stem walls, the in-plane shear strength in accordance with ACI 318-11 D.6.2 and D.6.3 need not be computed and ACI 318-11 D.3.3.5.3 need not apply provided all of the following are satisfied:

2.1. The maximum anchor nominal diameter is $5/8$ inch (16 mm).

2.2. Anchors are embedded into concrete a minimum of 7 inches (178 mm).

2.3. Anchors are located a minimum of $1^{3/4}$ inches (45 mm) from the edge of the concrete parallel to the length of the track.

2.4. Anchors are located a minimum of 15 anchor diameters from the edge of the concrete perpendicular to the length of the track.

2.5. The track is 33 to 68 mil designation thickness.

Allowable in-plane shear strength of exempt anchors, parallel to the edge of concrete shall be permitted to be determined in accordance with AISI S100 Section E3.3.1.

3. In light-frame construction, bearing or nonbearing walls, shear strength of concrete anchors less than or equal to 1 inch [25 mm] in diameter attaching a sill plate or track to foundation or foundation stem wall need not satisfy ACI 318-11 D.3.3.5.3(a) through (c) when the design strength of the anchors is determined in accordance with ACI 318-11 D.6.2.1(c).

4.2 Allowable Stress Design:

4.2.1 General: For anchors designed using load combinations in accordance with IBC Section 1605.3 (Allowable Stress Design), allowable loads shall be established using Eq. (4-2) or Eq. (4-3):

$$T_{allowable,ASD} = \frac{\phi N_n}{\alpha} \quad \text{Eq. (4-2)}$$

and

$$V_{allowable,ASD} = \frac{\phi V_n}{\alpha} \quad \text{Eq. (4-3)}$$

where

$T_{allowable,ASD}$ = Allowable tension load (lbf or kN)

$V_{allowable,ASD}$ = Allowable shear load (lbf or kN)

ϕN_n = Lowest design strength of an anchor or anchor group in tension as determined in accordance with ACI 318-14 Chapter 17 and 2015 IBC Section 1905.1.8, ACI 318-11 Appendix D, ACI 318-08 Appendix D and 2009 IBC Sections 1908.1.9 and 1908.1.10, ACI 318-05 Appendix D and 2006 IBC Section 1908.1.16, and Section 4.1 of this report, as applicable.

ϕV_n = Lowest design strength of an anchor or anchor group in shear as determined in accordance with ACI 318-14 Chapter 17 and 2015 IBC Section 1905.1.8, ACI 318-11 Appendix D, ACI 318-08 Appendix D and 2009 IBC Sections 1908.1.9 and 1908.1.10, ACI 318-05 Appendix D and 2006 IBC Section 1908.1.16, and Section 4.1 of this report, as applicable.

α = Conversion factor calculated as a weighted average of the load factors for the controlling load combination. In addition, α must include all applicable factors to account for non-ductile failure modes and required over-strength.

Limits on edge distance, anchor spacing and member thickness described in this report must apply.

Example calculations for derivation of $T_{allowable,ASD}$ are provided in Figure 2 and Table 7.

4.2.2 Interaction of tensile and shear forces: In lieu of ACI 318-14 17.6.1, 17.6.2 and 17.6.3 or ACI 318-11 D.7.1, D.7.2 and D.7.3, as applicable, interaction must be calculated as follows:

For shear loads $V \leq 0.2V_{allowable,ASD}$, the full allowable load in tension shall be permitted.

For tension loads $T \leq 0.2T_{allowable,ASD}$, the full allowable load in shear shall be permitted.

For all other cases:

$$\frac{T}{T_{allowable,ASD}} + \frac{V}{V_{allowable,ASD}} \leq 1.2 \quad \text{Eq. (4-4)}$$

4.3 Installation:

Installation parameters are illustrated in Figure 3 of this report. Installation must be in accordance with ACI 318-14 17.8.1 and 17.8.2 or ACI 318-11 D.9.1 and D.9.2, as applicable. Anchor locations must comply with this report and the plans and specifications approved by the code official. Installation of the Red Head A7+ Adhesive Anchor System must conform to the manufacturer's printed installation instructions included in each unit package, as provided in Figure 3 of this report.

The adhesive anchoring system may be used for floor (vertically down), wall (horizontal) and overhead applications. Horizontal and overhead applications are to be used with the $\frac{3}{8}$ -inch (9.5 mm) through $1\frac{1}{4}$ -inch-diameter (31 mm) threaded rods and reinforcing bars. The adhesive may be injected directly to the end of the hole using extension tubing (E916-6) for the $\frac{1}{2}$ -inch- through $1\frac{1}{4}$ -inch-diameter anchors, and extension tubing (E25-6) for the $\frac{3}{8}$ -inch-diameter anchors. Alternatively, the $\frac{5}{8}$ -inch- (16 mm) through $1\frac{1}{4}$ -inch-diameter (31 mm) threaded rod and reinforcing bars may be installed with a Red Head piston plug.

A demonstration video of the vertical down and overhead installation in dry concrete may be viewed from the following links:

<http://go.iccsafe.org/I/25182/2016-09-20/bv3v8h> for vertical down installation.

<http://go.iccsafe.org/I/25182/2016-09-20/bv3v79> for overhead installation with piston plugs.

4.4 Special Inspection:

4.4.1 General: Installations may be made under continuous special inspection or periodic special inspection, as determined by the registered design professional. Table 3 and Table 6 of this report provide strength reduction factors, ϕ , corresponding to the type of inspection provided.

Continuous special inspection of adhesive anchors installed in horizontal or upwardly inclined orientations to resist sustained tension loads shall be performed in accordance with ACI 318-14 17.8.2.4 or ACI 318-11 D.9.2.4, as applicable.

Under the IBC, additional requirements as set forth in Section 1705.1.1 and Table 1705.3 of the 2015 or 2012 IBC, and Sections 1705, 1706 or 1707 of the 2009, 2006, and 2003 IBC must be observed, where applicable.

4.4.2 Continuous Special Inspection: Installations made under continuous special inspection with an on-site proof loading program must be performed in accordance with Section 1705.1.1 and Table 1705.3 of the 2015 and 2012 IBC, Sections 1704.4 and 1704.15 of the 2009 IBC, or Section 1704.13 of the 2006 and 2003 IBC, whereby continuous special inspection is defined in Section 1702.1 of the IBC, and this report. The special inspector must be on the jobsite continuously during anchor installation to verify anchor type, adhesive expiration date, anchor dimensions, concrete type, concrete compressive strength, hole dimensions, hole cleaning procedures, anchor spacing, edge distances, concrete thickness, anchor embedment, tightening torque, and adherence to the manufacturers printed installation instructions.

The proof loading program must be established by the registered design professional. As a minimum, the following requirements must be addressed in the proof loading program:

1. Frequency of proof loading based on anchor type, diameter, and embedment.
2. Proof loads by anchor type, diameter, embedment, and location.
3. Acceptable displacements at proof load.
4. Remedial action in the event of a failure to achieve proof load, or excessive displacement.

Unless otherwise directed by the registered design professional, proof loads must be applied as confined tension tests. Proof load levels must not exceed the lesser of 67 percent of the load corresponding to the nominal bond strength as calculated from the characteristic bond stress for uncracked concrete modified for edge effects and concrete properties, or 80 percent of the minimum specified anchor element yield strength ($A_{se,N} \cdot f_{ya}$). The proof load shall be maintained at the required load level for a minimum of 10 seconds.

4.4.3 Periodic Special Inspection: Periodic special inspection must be performed where required in accordance with Section 1705.1.1 and Table 1705.3 of the 2015 and 2012 IBC, Section 1704.15 and Table 1704.4 of

the 2009 IBC, or Section 1704.13 of the 2006, and 2003 IBC, whereby periodic special inspection is defined in Section 1702.1 of the IBC and this report. The special inspector must be on the jobsite initially during anchor installation to verify anchor type, anchor dimensions, concrete type, concrete compressive strength, hole dimensions, hole cleaning procedures, anchor spacing, edge distances, concrete thickness, anchor embedment, tightening torque, and adherence to the manufacturer's printed installation instructions. The special inspector must verify the initial installations of each type and size of adhesive anchor by construction personnel on the site. Subsequent installations of the same anchor type and size by the same construction personnel are permitted to be performed in the absence of the special inspector. Any change in the anchor product being installed or the personnel performing the installation requires an initial inspection. For ongoing installations over an extended period, the special inspector must make regular inspections to confirm correct handling and installation of the product.

4.5 Compliance with NSF/ANSI Standard 61:

The A7+ Adhesive Anchor System complies with the requirements of NSF/ANSI Standard 61, as referenced in Section 605 of the 2009 and 2006 *International Plumbing Code*[®] (IPC), and is certified for use as an anchoring adhesive for installing threaded rods less than or equal to 1.3 inches (33 mm) in diameter in concrete for water treatment applications. An NSF/ANSI Standard 61 listing is provided by NSF International.

5.0 CONDITIONS OF USE

The Red Head A7+ Adhesive Anchoring System described in this report complies with or is a suitable alternative to what is specified in, those codes listed in Section 1.0 of this report, subject to the following conditions:

- 5.1 The Red Head A7+ Adhesive must be installed in accordance with the manufacturer's printed installation instructions, as included with the adhesive packaging and reproduced in Figure 3 of this report.
- 5.2 The anchors must be installed in cracked and uncracked normal-weight concrete having a specified compressive strength of $f'_c = 2,500$ psi to 8,500 psi (17.2 MPa to 58.6 MPa) [minimum of 24 MPa is required under ADIBC Appendix L, Section 5.1.1].
- 5.3 The values of f'_c used for calculation purposes must not exceed 8,000 psi (55 MPa).
- 5.4 Anchors must be installed in concrete base materials in holes predrilled in accordance with the instructions provided in Figure 3 of this report, using a carbide-tipped masonry drill bit manufactured within the range of the maximum and minimum drill-tip dimensions of ANSI B212.15-1994.
- 5.5 Loads applied to the anchors must be adjusted in accordance with Section 1605.2 of the IBC for strength design and in accordance with Section 1605.3 of the IBC for allowable stress design.
- 5.6 Red Head A7+ Adhesive Anchors are recognized for use in resisting short- and long-term loads, including wind and earthquake loads, subject to the conditions of this report.
- 5.7 In structures assigned to Seismic Design Category C, D, E or F under the IBC or IRC, anchor strength must comply with the requirements of 2009 IBC Section 1908.1.9 or 2006 IBC Section 1908.1.16
- 5.8 Red Head A7+ adhesive anchors are permitted to be installed in concrete that is cracked or that may be expected to crack during the service life of the anchor, subject to the conditions of this report.
- 5.9 Strength design values must be established in accordance with Section 4.1 of this report.
- 5.10 Allowable stress design values must be established in accordance with Section 4.2 of this report.
- 5.11 Minimum anchor spacing and edge distance, as well as minimum member thickness, must comply with the values given in this report.
- 5.12 Prior to anchor installation, calculations and details demonstrating compliance with this report must be submitted to the code official. The calculations and details must be prepared by a registered design professional where required by the statutes of the jurisdiction in which the project is to be constructed.
- 5.13 Anchors are not permitted to support fire-resistive construction. Where not otherwise prohibited by the code, anchors are permitted for installation in fire-resistive construction provided at least one of the following conditions is fulfilled:
 - Anchors are used to resist wind or seismic forces only.
 - Anchors that support gravity load-bearing structural elements are within a fire-resistive envelope or a fire-resistive membrane, are protected by approved fire-resistive materials, or have been evaluated for resistance to fire exposure in accordance with recognized standards.
 - Anchors are used to support nonstructural elements.
- 5.14 Since an ICC-ES acceptance criteria for evaluating data to determine the performance of adhesive anchors subjected to fatigue or shock loading is unavailable at this time, the use of these anchors under such conditions is beyond the scope of this report.
- 5.15 Use of zinc-plated carbon steel threaded rods or steel reinforcing bars is limited to dry, interior locations.
- 5.16 Use of hot-dipped galvanized carbon steel rods and stainless steel rods is permitted for exterior exposure or damp environments.
- 5.17 Steel anchoring materials in contact with preservative-treated and fire-retardant-treated wood must be of zinc-coated carbon steel or stainless steel. The minimum coating weights for zinc-coated steel must comply with ASTM A153.
- 5.18 Special inspection must be provided in accordance with Section 4.4 of this report. Continuous special inspection for anchors installed in horizontal or upwardly inclined orientations to resist sustained tension loads must be provided in accordance with Section 4.4 of this report.
- 5.19 Installation of anchors in horizontal or upwardly inclined orientations to resist sustained tension loads shall be performed by personnel certified by an applicable certification program in accordance with ACI 318-14 17.8.2.2 or 17.8.2.3; or ACI 318-11 D.9.2.2 or D.9.2.3, as applicable.
- 5.20 Red Head A7+ Adhesive Anchors may be used to resist tension and shear forces for floor (vertically

down), wall (horizontal) and overhead installations with concrete temperatures between 14°F and 110°F. Horizontal and overhead applications are to be used with the 3/8-inch (9.5 mm) through 1 1/4-inch (31 mm) diameter threaded rods and reinforcing bars. The adhesive must be injected directly to the back end of the hole using extension tubing (E916-6) for the 1/2-inch- through 1 1/4-inch-diameter anchors, and extension tubing (E25-6) for the 3/8-inch-diameter anchors. Alternatively, the 5/8-inch- (16 mm) through 1 1/4-inch-diameter (31 mm) threaded rod and reinforcing bars may be installed with a Red Head piston plug. See the MPII in Figure 3 of this report for temperature and installation requirements.

5.21 Anchors may be used for applications where the concrete temperature can rise from 40°F (or less) to 80°F (or higher) within a 12-hour period. Such applications may include but are not limited to anchorage of building facade systems and other applications subject to direct sun exposure.

5.22 Red Head A7+ Adhesive is manufactured under a quality-control program with inspections by ICC-ES.

6.0 EVIDENCE SUBMITTED

Data in accordance with the ICC-ES Acceptance Criteria for Post-installed Adhesive Anchors in Concrete Elements (AC308), dated June 2016, which incorporates requirements in ACI 355.4-11.

7.0 IDENTIFICATION

Red Head A7+ Adhesive is identified by labels on the adhesive cartridges bearing the adhesive manufacturer's name (ITW Commercial Construction North America) and address (Glendale Heights, Illinois), the product name (Red Head A7+), best-used-by expiration date, and the evaluation report number (ESR-3903).



FIGURE 1—RED HEAD EPCON A7+ ADHESIVE CARTRIDGES, DISPENSING TOOLS, MIXING NOZZLES, HOLE CLEANING BRUSHES AND HOLE PLUGS

TABLE 1—STEEL DESIGN INFORMATION FOR U.S. CUSTOMARY UNIT THREADED ROD ⁽¹⁾

CHARACTERISTIC	SYMBOL	UNITS	NOMINAL ROD DIAMETER (inch)							
			³ / ₈	¹ / ₂	⁵ / ₈	³ / ₄	⁷ / ₈	1	1 ¹ / ₄	
Threaded rod effective cross-sectional area	A_{se}	inch ²	0.078	0.142	0.226	0.335	0.462	0.606	0.969	
Carbon Steel A36	Nominal steel strength in tension	N_{sa}	lb	4,500	8,230	13,110	19,400	26,780	35,130	56,210
	Nominal steel strength in shear	V_{sa}	lb	2,700	4,940	7,870	11,640	16,070	21,080	33,730
	Strength reduction factor for tension, steel failure mode	φ	-	0.75	0.75	0.75	0.75	0.75	0.75	0.75
	Strength reduction factor for shear, steel failure mode ¹	φ	-	0.65	0.65	0.65	0.65	0.65	0.65	0.65
Reduction factor for seismic shear	α_{V,seis}	-	0.70	0.70	0.70	0.70	0.70	0.70	0.70	
Carbon Steel A193 B7	Nominal steel strength in tension	N_{sa}	lb	9,690	17,740	28,250	41,810	57,710	75,710	121,140
	Nominal steel strength in shear	V_{sa}	lb	5,810	10,640	16,950	25,090	34,630	45,430	72,680
	Strength reduction factor for tension, steel failure mode	φ	-	0.75	0.75	0.75	0.75	0.75	0.75	0.75
	Strength reduction factor for shear, steel failure mode ¹	φ	-	0.65	0.65	0.65	0.65	0.65	0.65	0.65
	Reduction factor for seismic shear	α_{V,seis}	-	0.70	0.70	0.70	0.70	0.70	0.70	0.70
Stainless Steel F593	F593 CW1 nominal steel strength in tension	N_{sa}	lb	7,365	13,480	21,470	-	-	-	-
	F593 CW1 nominal steel strength in shear	V_{sa}	lb	3,680	6,740	10,735	-	-	-	-
	F593 CW2 nominal steel strength in tension	N_{sa}	lb	-	-	-	25,385	35,110	46,055	73,645
	F593 CW2 nominal steel strength in shear	V_{sa}	lb	-	-	-	12,690	17,555	23,030	36,820
	Strength reduction factor for tension, steel failure mode ¹	φ	-	0.65	0.65	0.65	0.65	0.65	0.65	0.65
	Strength reduction factor for shear, steel failure mode	φ	-	0.60	0.60	0.60	0.60	0.60	0.60	0.60
Reduction factor for seismic shear	α_{V,seis}	-	0.70	0.70	0.70	0.70	0.70	0.70	0.70	

For **SI**: 1 inch = 25.4mm, 1 lbf = 4.45N, 1ft-lbf = 1.356 N-M, 1 psi = 0.006895 MPa.

¹The tabulated value of φ applies when the load combinations of Section 1605.2 of the IBC, ACI 318-14 5.3 or ACI 318-11 9.2 are used. If the load combinations of ACI 318-11 Appendix C are used, the appropriate value of φ must be determined in accordance with ACI 318-11 D.4.4.

TABLE 2—CONCRETE BREAKOUT DESIGN INFORMATION FOR U.S. CUSTOMARY UNIT THREADED ROD ⁽¹⁾

CHARACTERISTIC	SYMBOL	UNITS	NOMINAL ROD DIAMETER (inch)						
			$\frac{3}{8}$	$\frac{1}{2}$	$\frac{5}{8}$	$\frac{3}{4}$	$\frac{7}{8}$	1	$1\frac{1}{4}$
Effectiveness factor for uncracked concrete	k_{uncr}	-	24	24	24	24	24	24	24
Effectiveness factor for cracked concrete	k_{cr}	-	17	17	17	17	17	17	17
Minimum concrete thickness	h_{min}	in.	$h_{ef} + 1\frac{1}{4}$		$h_{ef} + 2d_o$				
Anchor embedment depth - minimum	$h_{ef,min}$	in.	$2\frac{3}{8}$	$2\frac{3}{4}$	$3\frac{1}{8}$	$3\frac{1}{2}$	$3\frac{1}{2}$	4	5
Minimum spacing	s_{min}	in.	$\frac{15}{16}$	$1\frac{1}{2}$	$2\frac{1}{2}$	3	$3\frac{1}{2}$	4	5
Minimum edge distance	c_{min}	in.	$\frac{15}{16}$	$1\frac{1}{2}$	$2\frac{1}{2}$	3	$3\frac{1}{2}$	4	5
Critical edge distance	c_{ac}	in.	See Section 4.1.10 of this report						
Strength reduction factor for tension, concrete failure mode ¹	ϕ	Cond. B	0.65	0.65	0.65	0.65	0.65	0.65	0.65
Strength reduction factor for shear, concrete failure mode ¹	ϕ	Cond. B	0.70	0.70	0.70	0.70	0.70	0.70	0.70

For SI: 1 inch = 25.4mm, 1 lbf = 4.45N, 1ft-lbf = 1.356 N-M, 1 psi = 0.006895 MPa.

¹The tabulated value of ϕ applies when the load combinations of Section 1605.2 of the IBC, ACI 318-14 5.3 or ACI 318-11 9.2 are used and the requirements of ACI 318-14 17.3.3 or ACI 318-11 D.4.3, as applicable, for Condition B are met. If the load combinations of ACI 318-11 Appendix C are used, the appropriate value of ϕ must be determined in accordance with ACI 318-11 D.4.4 for Condition B.

TABLE 3—RED HEAD EPON A7+ ADHESIVE ANCHOR BOND STRENGTH DESIGN INFORMATION FOR U.S. CUSTOMARY UNIT THREADED ROD^(1,4)

CHARACTERISTIC		SYMBOL	UNITS	NOMINAL ROD DIAMETER (inch)						
				³ / ₈	¹ / ₂	⁵ / ₈	³ / ₄	⁷ / ₈	1	1 ¹ / ₄
Anchor embedment depth - minimum		h_{ef}	in.	2 ³ / ₈	2 ³ / ₄	3 ¹ / ₈	3 ¹ / ₂	3 ¹ / ₂	4	5
Anchor embedment depth - maximum		h_{ef}	in.	7 ¹ / ₂	10	12 ¹ / ₂	15	17 ¹ / ₂	20	25
Temperature Range A ²	Characteristic Bond Strength for Uncracked Concrete	$\mathcal{T}_{k,uncr}$	psi	1,770	1,770	1,770	1,770	1,490	1,490	1,490
	Characteristic Bond Strength for Cracked Concrete	$\mathcal{T}_{k,cr}$	psi	1,060	790	860	890	695	655	585
Temperature Range B ³	Characteristic Bond Strength for Uncracked Concrete	$\mathcal{T}_{k,uncr}$	psi	1,275	1,275	1,275	1,275	1,080	1,080	1,080
	Characteristic Bond Strength for Cracked Concrete	$\mathcal{T}_{k,cr}$	psi	765	570	620	640	500	475	420
Continuous Inspection	Strength Reduction Factor - Dry Concrete	$\phi_{dry, ci}$	-	0.65	0.65	0.65	0.65	0.65	0.65	0.65
	Strength Reduction Factor - Water-Saturated Concrete	$\phi_{sat, ci}$	-	0.65	0.65	0.65	0.65	0.65	0.65	0.65
	Strength Reduction Factor - Water-Filled Holes	$\phi_{wf, ci}$	-	0.65	0.65	0.65	0.65	0.65	0.65	0.65
	Strength Reduction Factor - Submerged Concrete	$\phi_{sub, ci}$	-	0.65	0.55	0.55	0.65	0.65	0.55	0.65
Periodic Inspection	Strength Reduction Factor - Dry Concrete	$\phi_{dry, pi}$	-	0.55	0.55	0.55	0.55	0.55	0.55	0.65
	Strength Reduction Factor - Water-Saturated Concrete	$\phi_{sat, pi}$	-	0.65	0.65	0.65	0.65	0.65	0.65	0.65
	Strength Reduction Factor - Water-Filled Holes	$\phi_{wf, pi}$	-	0.65	0.65	0.65	0.65	0.65	0.65	0.65
	Strength Reduction Factor - Submerged Concrete	$\phi_{sub, pi}$	-	0.65	0.45	0.45	0.65	0.55	0.45	0.65
Reduction factor for seismic tension		$\alpha_{N,seis}$	-	0.89	0.75	0.76	0.66	0.77	0.80	0.80

For SI: 1 inch = 25.4mm, 1 lbf = 4.45N, 1ft-lbf = 1.356 N-M, 1 psi = 0.006895 MPa.

¹Bond strength values correspond to concrete compressive strengths ranging from 2,500 psi to 8,000 psi [minimum of 24 MPa is required under ADIBC Appendix L, Section 5.1.1].

²Temperature range A: Maximum short term temperature of 130°F and maximum long term temperature of 110°F.

³Temperature range B: Maximum short term temperature of 176°F and maximum long term temperature of 110°F.

⁴For structures assigned to IBC or IRC Seismic Design Category C, D, E, or F, bond strength values must be multiplied by $\alpha_{N,seis}$.

TABLE 4—STEEL DESIGN INFORMATION FOR U.S. CUSTOMARY UNIT REINFORCING BARS ⁽¹⁾

CHARACTERISTIC	SYMBOL	UNITS	NOMINAL ROD DIAMETER (inch)								
			No. 3	No. 4	No. 5	No. 6	No. 7	No. 8	No. 9	No. 10	
Nominal bar diameter	<i>d</i>	in.	3/8	1/2	5/8	3/4	7/8	1	1 1/8	1 1/4	
Reinforcing bar effective cross-sectional area	<i>A_{se}</i>	inch ²	0.11	0.2	0.31	0.44	0.6	0.79	1.00	1.27	
ASTM 615 Grade 60	Nominal steel strength in tension	<i>N_{sa}</i>	lb	9,900	18,000	27,900	39,600	54,000	71,100	90,000	114,300
	Nominal steel strength in shear	<i>V_{sa}</i>	lb	5,940	10,800	16,740	23,760	32,400	42,660	54,000	68,580
	Strength reduction factor for tension, steel failure mode	<i>φ</i>	-	0.65	0.65	0.65	0.65	0.65	0.65	0.65	0.65
	Strength reduction factor for shear, steel failure mode ¹	<i>φ</i>	-	0.60	0.60	0.60	0.60	0.60	0.60	0.60	0.60
	Reduction factor for seismic shear	<i>α_{v,seis}</i>	-	0.91	0.91	0.91	0.90	0.90	0.75	0.75	0.75

For SI: 1 inch = 25.4mm, 1 lbf = 4.45N, 1ft-lbf = 1.356 N-M, 1 psi = 0.006895 MPa.

¹The tabulated value of *φ* applies when the load combinations of Section 1605.2 of the IBC, ACI 318-14 5.3 or ACI 318-11 9.2 are used. If the load combinations of ACI 318-11 Appendix C are used, the appropriate value of *φ* must be determined in accordance with ACI 318-11 D.4.4.

TABLE 5—CONCRETE BREAKOUT DESIGN INFORMATION FOR U.S. CUSTOMARY UNIT REINFORCING BARS ^(1,2)

CHARACTERISTIC	SYMBOL	UNITS	NOMINAL ROD DIAMETER (inch)							
			No. 3	No. 4	No. 5	No. 6	No. 7	No. 8	No. 9	No. 10
Effectiveness factor for uncracked concrete	<i>k_{uncr}</i>	-	24	24	24	24	24	24	24	24
Effectiveness factor for cracked concrete	<i>k_{cr}</i>	-	17	17	17	17	17	17	17	17
Minimum concrete thickness	<i>h_{min}</i>	in.	<i>h_{ef}</i> + 1 1/4			<i>h_{ef}</i> + 2 <i>d_o</i>				
Anchor embedment depth - minimum	<i>h_{ef,min}</i>	in.	2 3/8	2 3/4	3 1/8	3 1/2	3 1/2	4	4 1/2	5
Minimum spacing	<i>s_{min}</i>	in.	1 5/16	1 1/2	2 1/2	3	3 1/2	4	4 1/2	5
Minimum edge distance	<i>c_{min}</i>	in.	1 5/16	1 1/2	2 1/2	3	3 1/2	4	4 1/2	5
Critical edge distance	<i>c_{ac}</i>	in.	See Section 4.1.10 of this report							
Strength reduction factor for tension, concrete failure mode ¹	<i>φ</i>	Cond. B	0.65	0.65	0.65	0.65	0.65	0.65	0.65	0.65
Strength reduction factor for shear, concrete failure mode ¹	<i>φ</i>	Cond. B	0.70	0.70	0.70	0.70	0.70	0.70	0.70	0.70

For SI: 1 inch = 25.4mm, 1 lbf = 4.45N, 1ft-lbf = 1.356 N-M, 1 psi = 0.006895 MPa.

¹The tabulated value of *φ* applies when the load combinations of Section 1605.2 of the IBC, ACI 318-14 5.3 or ACI 318-11 9.2 are used and the requirements of ACI 318-14 17.3.3 or ACI 318-11 D.4.3, as applicable, for Condition B are met. If the load combinations of ACI 318-11 Appendix C are used, the appropriate value of *φ* must be determined in accordance with ACI 318-11 D.4.4 for Condition B.

²The value of *f'_c* used for calculation must be limited to maximum 8,000 psi (55 MPa) in accordance with ACI 318-14 17.2.7 or ACI 318-11 D.3.7, as applicable.

TABLE 6—RED HEAD EPON A7+ ADHESIVE ANCHOR BOND STRENGTH DESIGN INFORMATION FOR U.S. CUSTOMARY UNIT REINFORCING STEEL ^(1,4)

CHARACTERISTIC	SYMBOL	UNITS	NOMINAL ROD DIAMETER (inch)								
			No. 3	No. 4	No. 5	No. 6	No. 7	No. 8	No. 9	No. 10	
Anchor embedment depth - minimum	h_{ef}	in.	2 ³ / ₈	2 ³ / ₄	3 ¹ / ₈	3 ¹ / ₂	3 ¹ / ₂	4	4 ¹ / ₂	5	
Anchor embedment depth - maximum	h_{ef}	in.	7 ¹ / ₂	10	12 ¹ / ₂	15	17 ¹ / ₂	20	22 ¹ / ₂	25	
Temperature Range A ²	Characteristic Bond Strength for Uncracked Concrete	$\mathcal{I}_{k,uncr}$	psi	1,675	1,935	1,900	1,700	1,635	1,615	1,585	1,550
	Characteristic Bond Strength for Cracked Concrete	$\mathcal{I}_{k,cr}$	psi	755	755	755	585	585	585	585	585
Temperature Range B ³	Characteristic Bond Strength for Uncracked Concrete	$\mathcal{I}_{k,uncr}$	psi	1,210	1,400	1,370	1,230	1,180	1,165	1,145	1,120
	Characteristic Bond Strength for Cracked Concrete	$\mathcal{I}_{k,cr}$	psi	545	545	545	420	420	420	420	435
Continuous Inspection	Strength Reduction Factor - Dry Concrete	$\phi_{dry, ci}$	-	0.65	0.65	0.65	0.65	0.65	0.65	0.65	0.65
	Strength Reduction Factor - Water-Saturated Concrete	$\phi_{sat, ci}$	-	0.65	0.65	0.65	0.65	0.65	0.65	0.65	0.65
	Strength Reduction Factor - Water-Filled Holes	$\phi_{wf, ci}$	-	0.65	0.65	0.65	0.65	0.65	0.65	0.65	0.65
	Strength Reduction Factor - Submerged Concrete	$\phi_{sub, aci}$	-	0.65	0.55	0.55	0.65	0.65	0.55	0.55	0.65
Periodic Inspection	Strength Reduction Factor - Dry Concrete	$\phi_{dry, pi}$	-	0.55	0.55	0.55	0.55	0.55	0.55	0.55	0.65
	Strength Reduction Factor - Water-Saturated Concrete	$\phi_{sat, pi}$	-	0.65	0.65	0.65	0.65	0.65	0.65	0.65	0.65
	Strength Reduction Factor - Water-Filled Holes	$\phi_{wf, pi}$	-	0.65	0.65	0.65	0.65	0.65	0.65	0.65	0.65
	Strength Reduction Factor - Submerged Concrete	$\phi_{sub, pi}$	-	0.65	0.45	0.45	0.65	0.55	0.45	0.45	0.65
Reduction factor for seismic tension	$\alpha_{N,seis}$	-	0.92	0.92	0.92	0.82	0.82	0.82	0.82	0.82	

For SI: 1 inch = 25.4mm, 1 lbf = 4.45N, 1ft-lbf = 1.356 N-M, 1 psi = 0.006895 MPa.

¹Bond strength values correspond to concrete compressive strengths ranging from 2,500 psi to 8,000 psi [minimum of 24 MPa is required under ADIBC Appendix L, Section 5.1.1].

²Temperature range A: Maximum short term temperature of 130°F and maximum long term temperature of 110°F.

³Temperature range B: Maximum short term temperature of 176°F and maximum long term temperature of 110°F.

⁴For structures assigned to IBC or IRC Seismic Design Category C, D, E, or F, bond strength values must be multiplied by $\alpha_{N,seis}$.

**TABLE 7—EXAMPLE RED HEAD EPCON A7+ ADHESIVE ALLOWABLE STRESS DESIGN VALUES (ASD)
FOR ILLUSTRATIVE PURPOSES**

Anchor Diameter (d)	Min/Max Embedment Depth, h _{ef} (in)	Char. Bond Strength τ _{k,uncr} (psi)	Allowable Tension Load (lb) 2500psi- 8000psi	Controlling Failure Mode
3/8	2 ³ / ₈	1,770	1,929	Concrete
	7 ¹ / ₂		2,280	Steel
1/2	2 ³ / ₄	1,770	2,403	Concrete
	10		4,171	Steel
5/8	3 ¹ / ₈	1,770	2,911	Concrete
	12 ¹ / ₂		6,644	Steel
3/4	3 ¹ / ₂	1,770	3,451	Concrete
	15		9,831	Steel
7/8	3 ¹ / ₂	1,490	3,451	Concrete
	17 ¹ / ₂		13,571	Steel
1	4	1,490	4,216	Concrete
	20		17,802	Steel
1 ¹ / ₄	5	1,490	5892	Concrete
	25		28,485	Steel

For **SI**: 1 inch = 25.4mm, 1 lbf = 4.45N, 1ft-lbf = 1.356 N-M, 1 psi = 0.006895 MPa.

This table was developed based on the following conditions:

- ¹Single anchor with static tension only, A36 threaded rod
- ²Vertical downward installation direction
- ³Inspection regimen = Periodic
- ⁴Installation temperature = 30°F to 90°F
- ⁵Long term temperature = 110°F
- ⁶Short term temperature = 130°F
- ⁷Dry hole condition (carbide drilled hole)
- ⁸Embedment = h_{ef} (min/max for each diameter)
- ⁹Concrete determined to remain uncracked for the life of the anchorage
- ¹⁰Load combinations from ACI 318-11 Section 9.2 (no seismic loading)
- ¹¹30% dead load and 70% live load, controlling load combination 1.2D + 1.6L
- ¹²Calculation of weighted average for α = 0.3*1.2 + 0.7*1.6 = 1.48
- ¹³f_c = 2,500 psi (normal weight concrete)
- ¹⁴c_{a1} = c_{a2} ≥ c_{ac}
- ¹⁵h ≥ h_{min}

Illustrative Procedure to Calculate Allowable Stress Design Tension Value:

Red Head Epcon A7+ Adhesive Anchor 1/2-inch diameter, using an embedment of 4 1/2 inches, assuming the conditions given in Table 7 (for use with the 2012 IBC, based on ACI 318-11 Appendix D). Applied tension load, $N_{ua} = 4,000$ lbs.

	PROCEDURE	CALCULATION
Step 1	Calculate steel strength of a single anchor in tension per ACI 318-11 D.5.1.2 and Table 1 of this report.	$\phi N_{sa} = 0.75 * 8,230 = 6,173$ lbs steel strength
Step 2	Calculate concrete breakout strength of a single anchor in tension per ACI 318-11 D.5.2 and Table 2 of this report.	$N_b = k_{c,uncr} * \lambda_a \sqrt{f'_c} h_{ef}^{1.5} = 24 * \sqrt{2,500} * 4.5^{1.5}$ $N_b = 11,455$ lbs $\phi N_{cb} = \phi A_{NC} / A_{NCO} \psi_{ed,N} \psi_{c,N} \psi_{cp,N} N_b$ $\phi N_{cb} = 0.65 * 1.0 * 1.0 * 1.0 * 11,455$ $\phi N_{cb} = 7,446$ lbs concrete breakout strength
Step 3	Calculate bond strength of a single anchor in tension per ACI 318-11 D.5.5 and Table 3 of this report.	$N_{ba} = * \lambda_a \tau_{k,uncr} \pi d h_{ef}$ $N_{ba} = 1.0 * 1,770 * 3.14 * 0.5 * 4.5$ $N_{ba} = 12,505$ lbs $\phi N_a = \phi A_{Na} / A_{Na0} \psi_{ed,Na} \psi_{cp,Na} N_{a0}$ $\phi N_a = 0.65 * 1.0 * 1.0 * 1.0 * 12,505$ $\phi N_a = 8,128$ lbs bond strength
Step 4	Determine compliance with required anchor strength per ACI 318-11 D.4.1.	$\phi N_{sa} = 6,173$ lbs > $N_{ua} = 4,000$ lbs $\phi N_{cb} = 7,446$ lbs > $N_{ua} = 4,000$ lbs $\phi N_a = 8,128$ lbs > $N_{ua} = 4,000$ lbs
Step 5	Calculate allowable stress design conversion factor for loading condition per ACI 318-11 Section 9.2.	$\alpha = 1.2D + 1.6L = 1.2(0.3) + 1.6(0.7) = 1.48$
Step 6	Calculate allowable stress design value per Section 4.2 of this report.	$T_{allowable,ASD} = \phi N_n / \alpha = 6,173$ lbs/1.48 $T_{allowable,ASD} = 4,171$ lbs allowable stress design

FIGURE 2—EXAMPLE DESIGN CALCULATION

RED HEAD EPCON A7+ ADHESIVE ANCHOR INSTALLATION INSTRUCTIONS

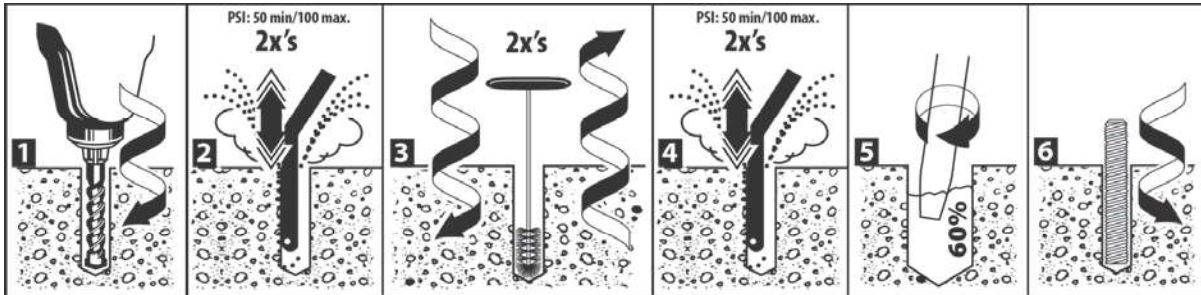

* Water-saturated concrete, water-filled holes and submerged concrete applications require 4x's air, 4x's brushing and 4x's air

- 1)
 - Use a rotary hammer drill or pneumatic air drill with a carbide drill bit complying to ANSI B212.15-1994 tolerance requirements. Drill hole to the required embedment depth. See attached table for drill bit specifications and min/maximum embedment depths.
 - Installations may be used with maximum 1-1/4" diameter rods/rebar for floor, wall and overhead applications.
 - Per construction specification, adhere to minimum spacing, minimum edge distance, and minimum member thickness.
 - 2)
 - For dry holes, oscillate a clean air nozzle in and out of the dry hole two times, for a total of two seconds, starting at the bottom of the hole with contaminant-free compressed air, exhausting hole until visually clean (i.e., no dust, debris, etc.)
 - For water-saturated concrete and water-filled hole applications, oscillate a clean air nozzle in and out of the damp, water-filled or submerged hole four times, for a total of four seconds, starting at the bottom of the hole with contaminant-free compressed air, exhausting hole until visually clean (i.e., no dust, debris, etc.)
 - If required, use an extension on the end of the air nozzle to reach the bottom of the hole.
 - 3)
 - Select an appropriately sized Red Head brush for the anchor diameter. Brush must be checked for wear before use. See attached table for brush specifications, including minimum diameter.
 - Insert the brush into the hole with a clockwise motion. For every 1/2" forward advancement, complete one full turn until bottom of hole is reached. For faster and more suitable cleaning, attach the brush to a drill.
 - Using a clockwise motion, for every full turn of the brush, pull the brush 1/2" out of the hole.
 - For dry holes, twist/spin the brush two times in/out of the hole.
 - For water-saturated concrete and water-filled hole applications, twist/spin the brush four times in/out of the hole.
 - If required, use a wire brush extension (part nos. ESDS-38 or EHAN-38) to reach the bottom of the hole.
 - Air clean the dust off the brush to prevent clogging of the brush.
 - 4)
 - For dry holes, oscillate a clean air nozzle in and out of the dry hole two times, for a total of two seconds, starting at the bottom of the hole with contaminant-free compressed air, exhausting hole until visually clean (i.e., no dust, debris, etc.)
 - For water-saturated concrete and water-filled hole applications, oscillate a clean air nozzle in and out of the damp, water-filled or submerged hole four times, for a total of four seconds, starting at the bottom of the hole with contaminant-free compressed air, exhausting hole until visually clean (i.e., no dust, debris, etc.)
 - 5)
 - Review the Safety Data Sheet (SDS) before use.
 - Check the "Use By" date on the cartridge and that the cartridge has been stored in out of direct sunlight.
 - Review the gel time/cure time chart, based on the temperature at time of installation, in order to determine tool, cartridge and nozzle requirements.
 - Assemble the Red Head supplied cartridge and nozzle. Do not modify or remove mixing elements in nozzle.
- If nozzle does not reach the bottom of the hole, use Red Head E25-6 extension tubing (0.44" O.D.) positioned on the end of nozzle or use the S75EXT (nozzle extension) on the end of the S75 nozzle.
 - Place the assembly into a hand injection tool or a pneumatic injection tool.
 - Dispense mixed adhesive outside of hole until uniform color is achieved.
 - During installations, concrete must be between 14 and 110 degrees F, or artificially maintained.
 - Insert the nozzle to the bottom of the hole and inject the adhesive at an angle, leaving the nozzle tip always slightly below the fill level.
 - In a slow circular direction, work the adhesive into the sides of the hole, filling slowly to ensure proper adhesive distribution, until the hole is approximately 60% filled.
 - For holes that contain water, keep injecting the adhesive below the water in order to displace the water upward.
- HORIZONTAL AND OVERHEAD INJECTION OF ADHESIVE:**
- For 3/8" thru 1 1/4" diameter anchors installed horizontal and overhead, the adhesive may be injected directly to the end of the hole using the Red Head E25-6 extension tubing (0.44" O.D.) for the 3/8" diameter anchors, and Red Head E916-6 extension tubing (0.56" O.D.) for the 1/2" thru 1 1/4" diameter anchors.
 - Alternatively, for 5/8" diameter rod (#5 rebar) and larger anchors installed horizontal and overhead, assemble Red Head E916-6 extension tubing and appropriate sized piston plug on end of tubing:
 - PL-5834 for 5/8" & 3/4" diameter rod (No. 5 and No. 6 rebar)
 - PL-7810 for 7/8" & 1" diameter rod (No. 7 and No. 8 rebar)
 - PL-1250 for 1-1/4" diameter rod (No. 9 and No. 10 rebar)
 - The use of the Red Head pneumatic tool may be required for larger diameter anchors and/or deeper embedment installations at temperatures up to 110 degrees F.
- 6)
 - Immediately insert the oil, rust and scale free rod/rebar assembly to the required embedment depth, using a counterclockwise motion to ensure proper adhesive distribution.
 - The anchor rod/rebar must be marked with the required embedment depth.
 - For wall (horizontal) and overhead installations with concrete or adhesive over 70 degrees F, the anchor rod/rebar must be marked with the required embedment depth and assembled with a Red Head hole plug positioned on the rod/rebar at the required embedment depth.
 - After installing the anchor, the gap between the rod and the concrete must be completely filled with adhesive. The adhesive must fill voids, crevices and uniformly coat the rod and concrete.
 - After installation, do not disturb the anchor until the full cure time has elapsed. Overhead installations must be supported until full cure time has elapsed.
 - Adhesive must be fully cured before applying any load or torque. Do not over torque the anchor as this could adversely affect its performance.

FIGURE 3—RED HEAD EPCON A7+ ADHESIVE INSTALLATION INSTRUCTIONS

SPECIFICATIONS FOR INSTALLATION OF RED HEAD EPCON S7 ADHESIVE ANCHORS IN CONCRETE

FOR INSTALLATION USING U.S. CUSTOMARY UNIT THREADED ROD

CHARACTERISTIC	SYMBOL	UNITS	NOMINAL ROD DIAMETER (inch)						
			$\frac{3}{8}$	$\frac{1}{2}$	$\frac{5}{8}$	$\frac{3}{4}$	$\frac{7}{8}$	1	$1\frac{1}{4}$
Nominal carbide bit diameter	-	in.	$\frac{7}{16}$	$\frac{9}{16}$	$\frac{3}{4}$	$\frac{7}{8}$	1	$1\frac{1}{8}$	$1\frac{3}{8}$
Anchor embedment depth - minimum	$h_{ef, min}$	in.	$2\frac{3}{8}$	$2\frac{3}{4}$	$3\frac{1}{8}$	$3\frac{1}{2}$	$3\frac{1}{2}$	4	5
Anchor embedment depth - maximum	$h_{ef, max}$	in.	$7\frac{1}{2}$	10	$12\frac{1}{2}$	15	$17\frac{1}{2}$	20	25
Minimum spacing	s_{min}	in.	$\frac{15}{16}$	$1\frac{1}{2}$	$2\frac{1}{2}$	3	$3\frac{1}{2}$	4	5
Minimum edge distance	c_{min}	in.	$\frac{15}{16}$	$1\frac{1}{2}$	$2\frac{1}{2}$	3	$3\frac{1}{2}$	4	5
Minimum concrete thickness	h_{min}	in.	$h_{ef} + 1\frac{1}{4}$			$h_{ef} + 2d_o$			
Maximum tightening torque for pretension clamping	T_{inst}	ft lb	9	16	47	70	90	110	370

FOR INSTALLATION USING U.S. CUSTOMARY UNIT REINFORCING BARS

CHARACTERISTIC	SYMBOL	UNITS	NOMINAL REBAR DIAMETER (inch)							
			No. 3	No. 4	No. 5	No. 6	No. 7	No. 8	No. 9	No. 10
Nominal carbide bit diameter	-	in.	$\frac{7}{16}$	$\frac{5}{8}$	$\frac{3}{4}$	$\frac{7}{8}$	1	$1\frac{1}{8}$	$1\frac{1}{4}$	$1\frac{3}{8}$
Anchor embedment depth - minimum	$h_{ef, min}$	in.	$2\frac{3}{8}$	$2\frac{3}{4}$	$3\frac{1}{8}$	$3\frac{1}{2}$	$3\frac{1}{2}$	4	$4\frac{1}{2}$	5
Anchor embedment depth - maximum	$h_{ef, max}$	in.	$7\frac{1}{2}$	10	$12\frac{1}{2}$	15	$17\frac{1}{2}$	20	$22\frac{1}{2}$	25
Minimum spacing	s_{min}	in.	$\frac{15}{16}$	$1\frac{1}{2}$	$2\frac{1}{2}$	3	$3\frac{1}{2}$	4	$4\frac{1}{2}$	5
Minimum edge distance	c_{min}	in.	$\frac{15}{16}$	$1\frac{1}{2}$	$2\frac{1}{2}$	3	$3\frac{1}{2}$	4	$4\frac{1}{2}$	5
Minimum concrete thickness	h_{min}	in.	$h_{ef} + 1\frac{1}{4}$			$h_{ef} + 2d_o$				

For SI: 1 inch = 25.4mm, 1 lbf = 4.45N, 1ft-lbf = 1.356N-m, 1psi = 0.006895MPa.

ANCHOR INSTALLATION

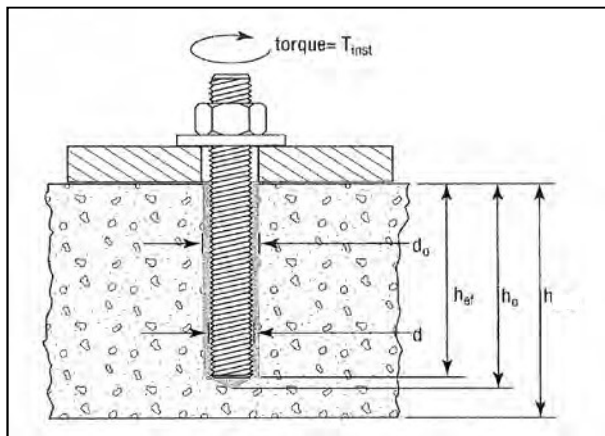

BRUSH SPECIFICATIONS

Anchor diameter (in)	Brush Part No.	Minimum brush diameter (in)
$\frac{3}{8}$ No. 3	SB038	0.563
$\frac{1}{2}$ No. 4	SB012	0.675
$\frac{5}{8}$ No. 5	SB058	0.900
$\frac{3}{4}$ No. 6	SB034	1.125
$\frac{7}{8}$ No. 7	SB078	1.350
1 No. 8, and No. 9	SB010	1.463
$1\frac{1}{4}$ No. 10	SB125	1.575

FIGURE 3—ITW RED HEAD S7 ADHESIVE INSTALLATION INSTRUCTIONS (Continued)

**MIXING NOZZLE, EXTENSION TUBING & PISTON PLUG SPECIFICATIONS
FOR HORIZONTAL AND OVERHEAD INSTALLATION ACCESSORIES**

Anchor diameter (in)	Mixing nozzle	Extension nozzle	Extension tubing	Piston plug
3/8	A24S	N/A ¹	E25-6 ⁴	N/A ¹
	S55			
1/2	A24S	N/A ¹	E916-6 ⁴	N/A ¹
	S55			
5/8	A24S	N/A ¹	E916-6 ⁴	N/A ¹
	S55			
	S75			
3/4	S55	N/A ¹	E916-6	N/A ¹
	S75	S75EXT	E916-6 ²	PL-5834 ²
7/8	S55	N/A ¹	E916-6	N/A ¹
	S75	S75EXT	E916-6 ²	PL-7810 ³
1	S55	N/A ¹	E916-6	N/A ¹
	S75	S75EXT	E916-6 ²	PL-7810 ³
1 1/4	S55	N/A ¹	E916-6	N/A ¹
	S75	S75EXT	E916-6 ²	PL-1250 ³

¹N/A = not available

²For use with the mixing nozzle S75 and extension nozzle S75EXT for horizontal and overhead installation in accordance with Section 4.3 of this report.

³For use with the mixing nozzle S75, extension nozzle S75EXT and extension tubing E916-6 for horizontal and overhead installation in accordance with Section 4.3 of this report.

⁴For use with the mixing nozzle A24S or S55 for horizontal and overhead installation in accordance with Section 4.3 of this report.

CURE TIMES AND GEL TIMES FOR RED HEAD EPCON A7+ ADHESIVE

Concrete Temperature (°F) ^{1,2}	Gel Time ³	Cure Time ⁴
110	1.5 minutes	45 minutes
90	5 minutes	45 minutes
70	10 minutes	45 minutes
50	16 minutes	90 minutes
32	35 minutes	4 hours
14	35 minutes	24 hours

For SI: t° (°F-32) X .555 = °C.

¹Adhesive must be installed in concrete temperatures within the noted range or artificially maintained at the noted temperature.

²For concrete temperatures between 14°F and 32°F, adhesive must be maintained at a minimum of 32°F during installation.

³Gel time is the maximum time from the end of mixing to when the insertion of the anchor into the adhesive shall be completed and is based upon the adhesive and concrete temperatures noted.

⁴Cure time is the minimum time from the end of gel time to when the anchor maybe torque or loaded. Anchors are to be undisturbed during the cure time.

FIGURE 3—RED HEAD A7+ ADHESIVE INSTALLATION INSTRUCTIONS (Continued)

ICC-ES Evaluation Report

ESR-3903 FBC Supplement

Issued December 2016

This report is subject to renewal December 2017.

www.icc-es.org | (800) 423-6587 | (562) 699-0543

A Subsidiary of the International Code Council®

DIVISION: 03 00 00—CONCRETE

Section: 03 16 00—Concrete Anchors

DIVISION: 05 00 00—METALS

Section: 05 05 19—Post-Installed Concrete Anchors

ITW RED HEAD

700 HIGH GROVE BOULEVARD

GLENDALE HEIGHTS, ILLINOIS 60139

(800) 848-5611

www.itw-redhead.com

techsupport@itwccna.com

EVALUATION SUBJECT:

ITW RED HEAD A7+ ADHESIVE ANCHORING SYSTEM FOR CRACKED AND UNCRACKED CONCRETE

1.0 REPORT PURPOSE AND SCOPE

Purpose:

The purpose of this evaluation report supplement is to indicate that Red Head A7+ Adhesive Anchoring System for Cracked and Uncracked Concrete, recognized in ICC-ES master evaluation report ESR-3903, has also been evaluated for compliance with the codes noted below.

Compliance with the following codes:

- 2014 *Florida Building Code—Building*
- 2014 *Florida Building Code—Residential*

2.0 PURPOSE OF THIS SUPPLEMENT

This supplement is issued to indicate that the Red Head A7+ Adhesive Anchoring System for Cracked and Uncracked Concrete described in Sections 2.0 through 7.0 of the master report, ESR-3903, complies with the 2014 *Florida Building Code—Building* and the 2014 *Florida Building Code—Residential*, when designed and installed in accordance with the 2012 *International Building Code*® (IBC) provisions noted in the master evaluation report under the following conditions:

- Design wind loads must be based on Section 1609 of the 2014 *Florida Building Code—Building* or Section 301.2.1.1 of the 2014 *Florida Building Code—Residential*, as applicable.
- Load combinations must be in accordance with Section 1605.2 or Section 1605.3 of the 2014 *Florida Building Code—Building*, as applicable.

Use of the Red Head A7+ Adhesive Anchoring System with stainless steel threaded rod materials has also been found to be in compliance with the High-Velocity Hurricane Zone provisions of the 2014 *Florida Building Code—Building* and the 2014 *Florida Building Code—Residential* when the following condition is met:

The design wind loads for use of the anchors in a High-Velocity Hurricane Zone are based on Section 1620 of the *Florida Building Code—Building*.

Use of the the Red Head A7+ Adhesive Anchoring System with carbon steel threaded rod materials and reinforcing bars for compliance with the High-velocity Hurricane Zone provisions of the 2014 *Florida Building Code—Building* and the 2014 *Florida Building Code—Residential* has not been evaluated and is outside the scope of this supplemental report.

For products falling under Florida Rule 9N-3, verification that the report holder's quality-assurance program is audited by a quality-assurance entity approved by the Florida Building Commission for the type of inspections being conducted is the responsibility of an approved validation entity (or the code official, when the report holder does not possess an approval by the Commission).

This supplement expires concurrently with the master report, issued December 2016 and corrected December 5, 2016.